

SKEMA

INDOOR TOP LEVEL LUMBERTECH
PAVIMENTI SOPRAELEVATI RAISED FLOORING



SKEMA

Superfici da vivere, dal 1992
Living surfaces, since 1992

Top Level Lumbertech

Il legno tecnico integra estetica e prestazioni, aumentando il valore intrinseco e quello percepito.

Technical wood blends beauty and performance, elevating both its essence and the way it is experienced.

La rivoluzione del pavimento in legno si esprime anche nella versione sopraelevata: Lumbertech è una superficie innovativa, certificata e sostenibile, proposta in un'ampia gamma di decori per rispondere alle più diverse esigenze progettuali. I pannelli, applicabili alla struttura regolabile, possono essere realizzati in truciolare o in solfato di calcio, permettendo di scegliere la soluzione più adatta in base ai requisiti di resistenza, stabilità e prestazioni acustiche richieste dal cliente. Lumbertech, nei pavimenti sopraelevati, rappresenta la sintesi tra innovazione, sostenibilità e design, offrendo al progettista la possibilità di introdurre il legno e il suo valore estetico in ambienti in cui usualmente si prediligono le superfici fredde, garantendo naturalità, funzionalità e prestazioni elevate.

The revolution in wood flooring also extends to raised access applications: Lumbertech is an innovative, certified, and sustainable surface, offered in a wide range of decors to meet diverse design requirements. The panels, applied onto the adjustable structure, can be manufactured in chipboard or calcium sulphate, allowing the most suitable solution to be chosen according to specific demands for strength, stability, and acoustic performance. In raised access floors, Lumbertech represents the perfect synthesis of innovation, sustainability, and design, giving designers the opportunity to introduce wood and its aesthetic value into environments traditionally dominated by colder surfaces, while ensuring natural appeal, functionality, and outstanding performance.



Product
Top Level Lumbertech - Rovere Brenta

ROVERE ARCHES/ 1438-1453

600x600x39 mm
600x600x41 mm

ROVERE ONTARIO/ 1440-1452

600x600x39 mm
600x600x41 mm

ROVERE BRENTA/ 1451-1455

600x600x39 mm
600x600x41 mm



Dati tecnici

Technical data

STRATIGRAFIA/ STRATIGRAPHY

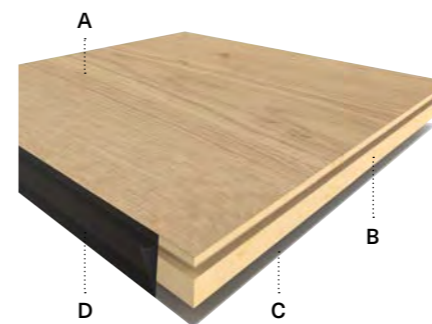



- A. Rivestimento con pavimento Lumbertech**
Lumbertech flooring covering
- B. Pannello di truciolare o solfato di calcio**
Particleboard or calcium sulphate panel
- C. Foglio di alluminio**
Aluminum foil
- D. Bordo in ABS nero**
Black ABS edge

FORMATI/ FORMATS

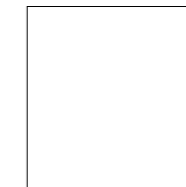
Top Level Lumbertech
600×600×39/41 mm



CARATTERISTICHE TECNICHE/ TECHNICAL FEATURES

Reazione al fuoco Fire reaction		Bfl-s1	Resistenza all'urto di corpi duri e morbidi Impact resistance of hard and soft bodies	Test superato Test passed
Formaldeide Formaldehyde		E1	Deformazione permanente dopo il carico Permanent deformation after loading EN 12825	< 0,5 mm
Pannello Panel	Truciolare o solfato di calcio Particleboard or calcium sulphate		Carico massimo di rottura Maximum breaking load	Vedi scheda tecnica See data sheet
			Classe dell'elemento Element class EN 12825	

CONFEZIONAMENTO/ PACKAGING

Rif. formato/ Size	Pezzi Cfz/ Pieces Box	m ² Cfz/ Box	Cfz Pallet/ Box Pallet	m ² Pallet
600×600 mm	1	0,36	48/ 56	VAR

ACCESSORI
ACCESSORIES

Battiscopa

Skirting boards

STAR

TIME

LOOK



Battiscopa in HDF con proporzioni standard.
HDF skirting board with standard proportions.

Battiscopa in HDF.
Skirting board made of HDF.

Battiscopa in HDF con finitura poro.
Skirting board made of HDF with a pore finish.

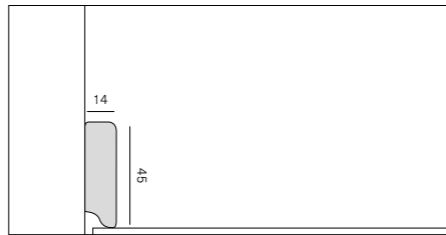
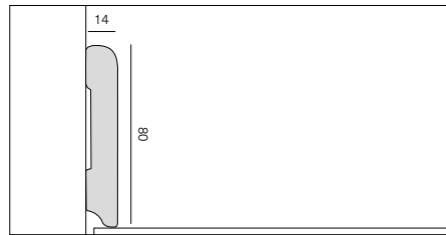
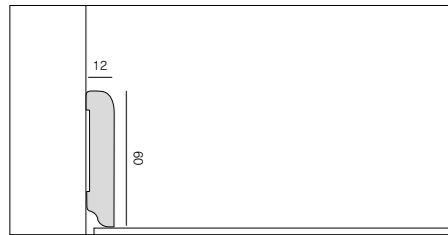

DROP

PVC ESPANSO

F

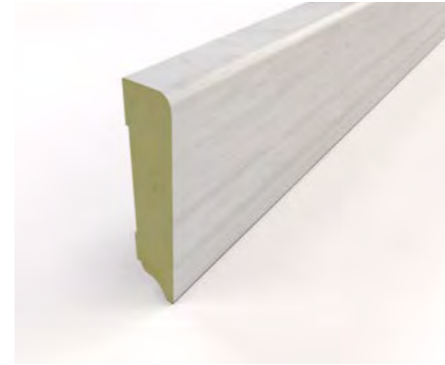

Battiscopa in HDF a bassa assorbenza con finiture poro. Con densità di 700 kg/m³ offre alta resistenza all'umidità.
HDF skirting board with low absorbency and a sealed finish. Its 700 kg/m³ density ensures high moisture resistance.

Battiscopa in PVC espanso resistente all'umidità.
Moisture-resistant expanded PVC skirting board.

Battiscopa realizzato con sistema folding utilizzando le relative doghe del pavimento.
Skirting board made with a folding system using the matching floor planks.

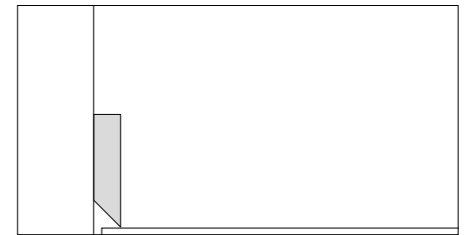
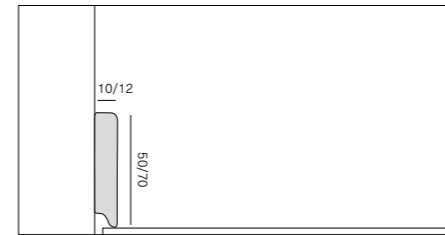
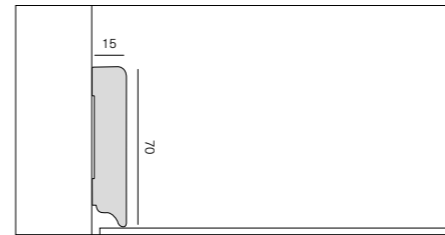

ABACO / RECAP

	STAR	TIME	LOOK
Abbinati Matching	Facile+	Prestige L Prestige Gold	Prestige L Prestige Gold Vision Technic
Abbinabili Combined	Syncro Parquet	Lumbertech	-
Tinta unita Solid colors	○ Bianco opaco/ Matt white	○ Bianco lucido/ Glossy white ○ Bianco opaco/ Matt white ○ Grigio chiaro/ Light grey ● Grigio medio/ Medium grey ● Grigio scuro/ Dark grey ● Nero opaco/ Matt black ● Carbonio/ Carbon ○ Beige ○ Avorio/ Ivory ● Metallo bronzo/ Bronze metal	● Alluminio/ Aluminum ○ Bianco lucido/ Glossy white ○ Bianco opaco/ Matt white ○ Grigio chiaro/ Light grey ● Grigio medio/ Medium grey ● Grigio scuro/ Dark grey ● Nero opaco/ Matt black ● Carbonio/ Carbon ○ Beige ○ Avorio/ Ivory ● Metallo bronzo/ Bronze metal
Dimensioni Size	h 60-2400x12 mm	h 80-2400x14 mm	h 45-2400x14 mm h 45-2200x14 mm

ABACO / RECAP

	DROP	PVC ESPANSO	F
Abbinati Matching	K-Uno	Star K Star KR Star KC Star KD Connex	Yes
Abbinabili Combined	-	Star KS Star Wood Star Wood Spina	-
Tinta unita Solid colors	○ Bianco/ White - RAL 9003, 9010	○ Bianco/ White - RAL 9003, 9010 ● Nero/ Black ● Alluminio/ Aluminum - RAL 9006	-
Dimensioni Size	h 70-2400x15 mm	h 50-2400x12 mm h 70-2400x12 mm	Variabile/ Variable

Profili Profiles

W45



Profilo per battiscopa realizzato in MDF rivestito di tranciato di vero legno con finiture verniciate a poro aperto (gruppo 1) e, per i colorati, con stampa digitale successivamente verniciato (gruppo 2).

Skirting board profile made of MDF and covered with real wood veneer. Two types of finishings available: open pore varnished finishing (group 1) and a coloured finishing made by digital printing process and then varnished (group 2).

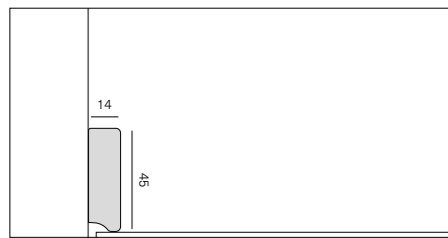

W75



Profilo per battiscopa realizzato in MDF rivestito di tranciato di vero legno con finiture verniciate a poro aperto (gruppo 1) e, per i colorati, con stampa digitale successivamente verniciato (gruppo 2).

Skirting board profile made of MDF and covered with real wood veneer. Two types of finishings available: open pore varnished finishing (group 1) and a coloured finishing made by digital printing process and then varnished (group 2).

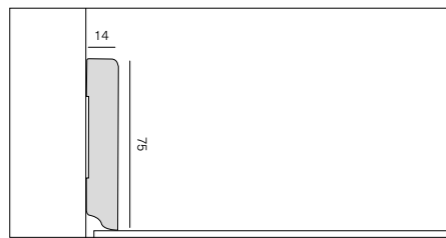

ABACO / RECAP

	W45	W75
Abbinabili Combined	Palladio Yles	Palladio Yles
Dimensioni Size	h 45-2400x14 mm	h 75-2400x14 mm

PARAGRADINO ANTISDRUCCIOLO
NO-SLIP STAIR PROTECTOR



Paragradino antiscivolo in alluminio, che consente di rivestire il raccordo tra alzata e pedata di una scala. Acquistare sempre con antiscivolo autoadesivo. Non-slip aluminum stair nosing, used to cover the transition between the riser and tread of a staircase. Always purchase with self-adhesive non-slip tape.

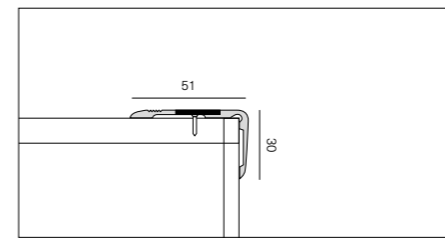

ANGOLARE AD L
L-SHAPED CORNER PROFILE

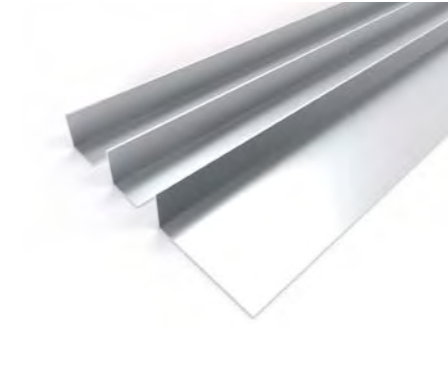

Profilo in alluminio per finiture di raccordi a muro. Aluminium profile for finishing wall connections.

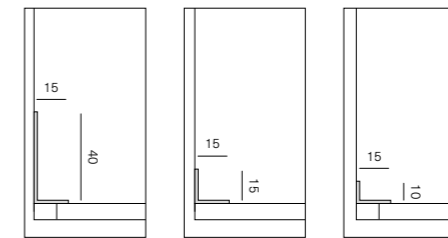

PROFILO DI BORDO
BORDER PROFILE

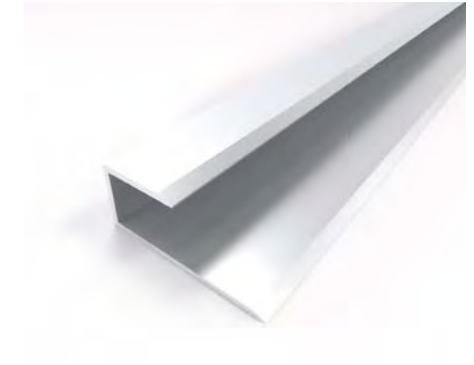

Profilo in alluminio estruso per bordature perimetrali per pavimenti. Extruded aluminium profile for perimeter edging of floors.

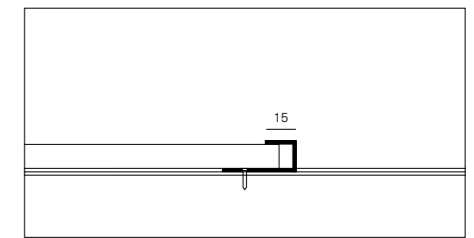

ABACO / RECAP

	PARAGRADINO ANTISDRUCCIOLO NO-SLIP STAIR PROTECTOR	ANGOLARE AD L L-SHAPED CORNER PROFILE	PROFILO DI BORDO BORDER PROFILE
Collezioni Lines	Pavimenti tecnici/ Technical flooring SPC Legni/ Wood	Pavimenti tecnici/ Technical flooring SPC Legni/ Wood	Pavimenti tecnici/ Technical flooring SPC Legni/ Wood
Tinta unita Solid colors	● Argento anodizzato/ Anodized silver ● Oro anodizzato/ Anodized gold ● Bronzo anodizzato/ Anodized bronze	● Argento/ Silver ● Bronzo/ Bronze	● Argento/ Silver ● Oro/ Gold
Dimensioni Size	3400x52x30 mm 18 m rotolo striscia antiscivolo autoadesiva/ 18 m roll self-adhesive non-slip strip	● 2000/3000x15x10 mm spessore 1,0 mm/ 1.0 mm thick ● 2000x15x15 mm spessore 1,5 mm/ 1.5 mm thick ● 2000x45x40 mm spessore 2,0 mm/ 2.0 mm thick	2700x15x6 mm 2700x15x7 mm 2700x15x9 mm 2700x15x11 mm 2700x15x15 mm

KIT TERMINALE
TERMINAL KIT



Kit terminale in alluminio con Pin Unico per pavimenti con spessore da 9 a 12,5 mm con base femmina in alluminio.
Aluminium end kit with Single Pin for floors with thickness from 9 to 12.5 mm, with aluminium female base.

CLIP DI AGGANCIO
RETAINING CLIP



Clip di aggancio in metallo zincato nero che, con rotazione sull'omega, fissa pannelli e doghe alla struttura.
Black galvanized metal clip that, by rotating onto the omega, secures panels and slats to the structure.

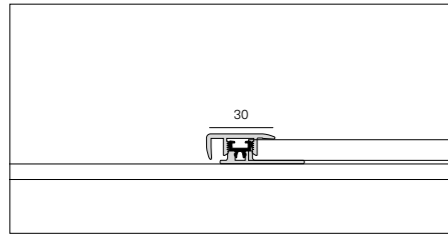

ABACO / RECAP

	KIT TERMINALE TERMINAL KIT	CLIP DI AGGANCIO RETAINING CLIP
Collezioni Lines	Pavimenti tecnici/ Technical flooring Legni/ Wood	K-Uno Prestige L Lumbertech
Tinta unita Solid colors	● Argento/ Silver	-
Dimensioni Size	2700x30 mm	44x41 mm
Confezione Packaging	-	200 pz/ pcs

Accessori per pavimenti sopraelevati

Accessories for raised floors

COLONNA BASE FILETTATA
COLUMN WITH THREADED BASE



Altezza Min Max 40-60 mm
Min-Max Height 50-80 mm
60-100 mm
100-150 mm

COLONNA BASE INNESTATA
COLUMN WITH EMBEDDED BASE



Altezza Min Max 120-180 mm
Min-Max Height 140-190 mm
160-230 mm
190-260 mm
220-290 mm
260-330 mm
300-370 mm
340-410 mm
380-450 mm
420-490 mm
460-530 mm

TRAVERSO CON GUARNIZIONE BASIC
CROSS-PIECE WITH SEAL BASIC



Dimensioni 35 mm
Size spessore 0,9 mm/
0,9 mm thick

Accessori per rivestimenti a parete e soffitto

Accessories for wall and ceiling coverings

PROFILO COMPLETAMENTO
COMPLETION KIT



PROFILO OMEGA
OMEGA PROFILE

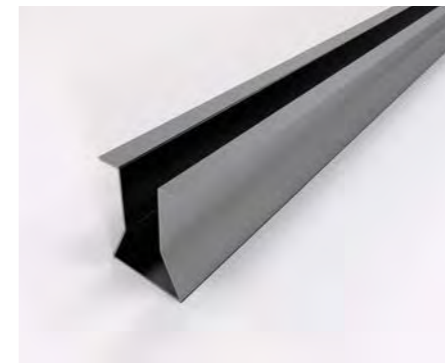

Il profilo ad omega costituisce l'elemento per il fissaggio a parete tramite viti o tasselli e deve essere montato ad una struttura portante tipo cartongesso o al muro da rivestire.

Omega cross-section profile is the element that fastens the boards to the wall. It must be installed using screws or wall plugs to a load bearing structure, such as drywall or the wall to be covered.

ABACO / RECAP

	PROFILO COMPLETAMENTO COMPLETION KIT	PROFILO OMEGA OMEGA PROFILE
Collezioni Lines	Star KW	-
Dimensioni Size	2700x4,5 mm	3000x25x26 mm 3000x13x26 mm

Posa Laying

KIT MORSETTI TELESCOPICI TELESCOPIC CLAMP KIT



In fase di partenza il muro non è mai regolare. I morsetti permettono di registrare la distanza tra muro e pavimento in senso longitudinale, accelerando le fasi di posa di un pavimento flottante. Consigliati 2 kit per posatore.

When starting, walls are never perfect. These clamps allow you to register the horizontal distance between the wall and the flooring, for more rapid installation.

2 kits per installer are recommended.

Collezioni
Lines

Pavimenti tecnici/
Technical flooring
Legni/ Wood

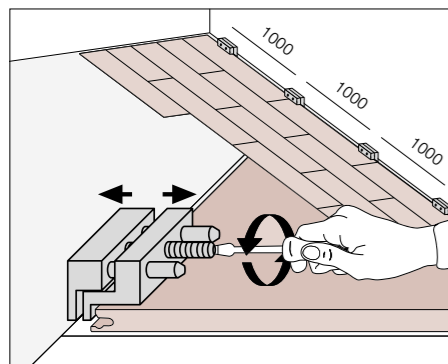

GRIMALDELLO PICKLOCK



È indispensabile per completare l'ultima fila di pavimento, in quanto non c'è spazio per la manovra del martello. Solo per incastri SLS e PLS (no TLS). Consigliato 1 pezzo per posatore.

This tool is required for finishing the last row of the flooring as there is no place enough for using the hammer.

We recommend 1 tool per installer.

Collezioni
Lines

Pavimenti tecnici/
Technical flooring
Legni/ Wood

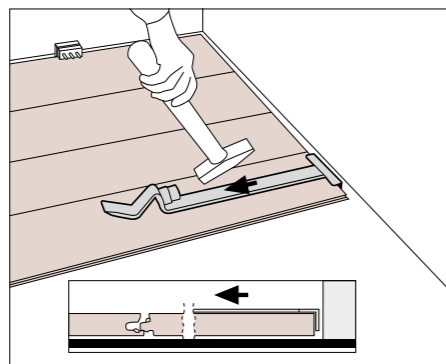

TENSIONATORE CINGHIA BELT TENSIONER



Per pavimenti con incastro a colla. Strumento per compattare le prime tre/ quattro file di doghe, fondamentali per la buona riuscita del lavoro soprattutto con colori chiari su incastri tradizionali a colla. Consigliati 6 pezzi per posatore.

For floorings with glued joints. Used to compact the first three or four rows of planks. Fundamental for good installation, especially for light colours with traditional glued joints.

6 units per installer are recommended.

Collezioni
Lines

Pavimenti tecnici/
Technical flooring
Legni/ Wood

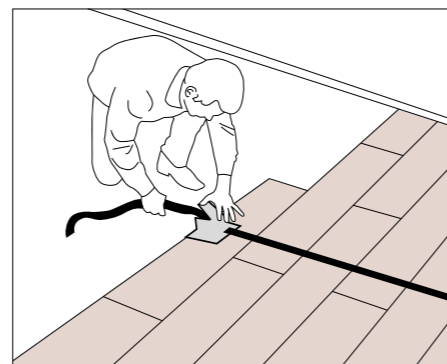

DISTANZIATORE PER PAVIMENTI FLOTTANTI SPACER FOR FLOATING FLOORING



Nei casi in cui si debba fissare al pavimento elementi di arredo o funzionali, consente di evitare il bloccaggio delle dilatazioni del pavimento e conseguenti sollevamenti dello stesso.

If you need to fasten pieces of furniture or functional elements to the flooring, it avoids blocking the flooring expansion and its consequent raising.

Collezioni
Lines

Pavimenti tecnici/
Technical flooring

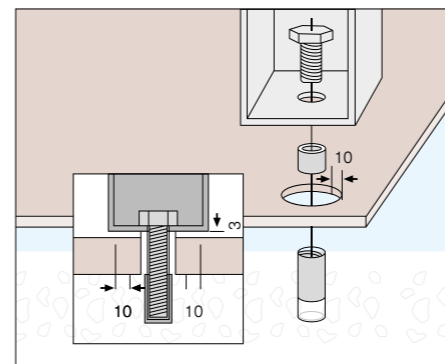

DISTANZIATORE PER PAVIMENTI AV2 AV2 SPACER FOR FLOORING



Distanziatore in plastica per pavimenti flottanti, regolabile 5-20 mm.

Plastic spacer for floating floors, adjustable 5-20 mm.

Collezioni
Lines

Pavimenti tecnici/
Technical flooring
Legni/ Wood

BATTITAVOLA PAVIMENTI TECNICI TECHNICAL FLOORING STAVES ALIGNER



Indispensabile per raccordare le doghe. Consigliato 1 pezzo per posatore.

Avvertenza: Usare esclusivamente battitavola originali per evitare di danneggiare l'incastro in modo irreparabile.

Indispensable for aligning the edge of the panels. We recommend 1 tool per installer.

Notice: Use only original Staves Aligner to avoid irreparable damages to the joint.

Collezioni
Lines

Pavimenti tecnici/
Technical flooring

ACCESSORI DI MONTAGGIO INSTALLATION ACCESSORIES



Accessori complementari utili per un lavoro preciso e veloce.

Accessories complementary for accurate, rapid installation.

Collezioni
Lines

Pavimenti tecnici/
Technical flooring

COLLA NUNIVIL 1008 (D3)
GLUE NUNIVIL 1008 (D3)



Adesivo acetovinilico per pavimenti flottanti con incastro M/F. Consumo medio 35–40 g/m². Consultare la documentazione tecnica sul sito.
Special vinyl adhesive for floating floors with M/F joint. Average consumption 35–40 g/m². Refer to the technical documentation on the website.

Collezioni Pavimenti tecnici/
Lines Technical flooring
Legni/ Wood

Confezione 500 gr
Packaging

**COLLA ISOCOLL 6307 BEIGE
PER BATTISCOPA PVC ESPANSO**
GLUE ISOCOLL 6307 BEIGE
FOR EXPANDED PVC SKIRTING BOARDS



Colla poliuretana monocomponente per un ottimo fissaggio del battiscopa in PVC espanso su diverse superfici.
Single component polyurethane adhesive for excellent fastening of expanded PVC skirting board on different surfaces.

Collezioni SPC
Lines

Confezione 290 ml
Packaging

**COLLA ISOCOLL ECO 6056 BIANCO
PER SCALE BATTISCOPA**
GLUE ISOCOLL ECO 6056 WHITE
FOR STEPS AND SKIRTING BOARDS



Colla monocomponente per il fissaggio del battiscopa e incollaggio gradini.
Single component adhesive for fastening skirting and stair elements.

Collezioni Pavimenti tecnici/
Lines Technical flooring
Legni/ Wood

Confezione 290 ml
Packaging

WAX CARE SPRAY



Wax care è una dispersione di cere idrorepellenti per la protezione di pavimenti in legno verniciati o oliati.
Wax care is a dispersion of water-repellent waxes for protection of varnished or oiled wooden floors.

Collezioni Star Wood
Lines Star Wood Spina
Legni/ Wood

Confezione -
Packaging

PARKETTREINIGER



Detergente per parquet a base di sapone naturale, pH neutro, ideale per la pulizia periodica di pavimenti in legno verniciati o oliati.
Parquet cleaner, natural soap-based, pH-neutral, ideal for regular cleaning of varnished or oiled wooden floors.

Collezioni Lumbertech 270 Oil
Lines Palladio
Yles

Confezione 1 L
Packaging

DETERGENTE MANUTENTORE CEROSO
WAXY MAINTENANCE CLEANER



Prodotto di manutenzione trasparente a base di cere naturali per il rinnovo ciclico dei pavimenti in legno.
Transparent maintenance product based on natural waxes for the cyclical renewal of wooden floors.

Collezioni Lumbertech 270 Oil
Lines Palladio
Yles

Confezione 1 L
Packaging

Cura e manutenzione
Care and maintenance

PULISYSTEM



Detergente igienizzante.
Sanitizing detergent.

Collezioni Pavimenti tecnici/
Lines Technical flooring
Lumbertech
SPC

Confezione 1 L
Packaging

SANITOTAL



Detergente decontaminante.
Attenzione: da utilizzarsi dopo aver lavato le superfici con il prodotto pulisystem.
Decontaminant detergent.
Warning: use only after cleaning surfaces with Pulisystem.

Collezioni Pavimenti tecnici/
Lines Technical flooring
Lumbertech
SPC

Confezione 1 L
Packaging

MULTILAYER CLEANER



Detergente antistatico sanificante adatto alla pulizia di pavimenti tecnici e vinilici.
Antistatic sanitizing cleaner for technical and vinyl flooring.

Collezioni Pavimenti tecnici/
Lines Technical flooring
SPC

Confezione 1 L
Packaging

OLIO PER RITOCOCCO
RETOUCHING OIL



Olio per ritocco e ripristino.
Touch-up and restoration oil.

Collezioni Lumbertech 270 Oil
Lines

Confezione 0,125 L
Packaging

CLEANER STAR



Detergente intensivo multiuso per la pulizia di pavimenti in legno verniciati/ olio UV.
Intensive multipurpose cleaner for varnished and UV-oiled wooden floors.

Collezioni Lumbertech 270
Lines Varnish, 205, S700
Palladio

Confezione -
Packaging

OSMO POLYX OIL 3062 MATT



Trattamento speciale di oliatura.
Special oiling treatment.

Collezioni Lumbertech 270 Oil
Lines

Confezione -
Packaging

**PACKAGING
E LOGISTICA**
PACKAGING
AND LOGISTICS

Pavimenti sopraelevati

Raised flooring

Prodotto Product	Rif. formato mm Size mm	Pezzi Cfs Pieces Box	m ² Cfs m ² Box	Dimensioni scatola mm Box dimensions mm	Kg per scatola Kg per box	Cfs pallet Box pallet	m ² pallet m ² pallet	Dimensione pallet (mm) Pallet dimensions (mm)	Kg pallet al m ² Pallet kg per m ²	Peso lordo pallet Pallet Weight
TOP LEVEL LUMBERTECH	600x600x39/41	1	0,36	600x600	VAR	48/ 56	VAR	1260x660x960	VAR	VAR
TOP LEVEL PRESTIGE L	600x600x36/38	1	0,36	600x600	VAR	48/ 56	VAR	1260x660x960	VAR	VAR
TOP LEVEL VISION TECHNIC	600x600x36/38	1	0,36	600x600	VAR	48/ 56	VAR	1260x660x960	VAR	VAR

Skema S.p.A.

Via dell'Artigianato, 8
31047 Ponte di Piave (TV) - Italy

Ph. (+39) 0422 858511
info@skema.eu
www.skema.eu

A.D.

arch. paolo pampanoni

Concept & Graphic

d+a srl

Set design, rendering

virtual design
nudesign srl

Photo

studio antiorario

Printed

grafiche antiga

La riproduzione dei colori è approssimativa.

Skema S.p.A. ha la facoltà esclusiva di modificare e sostituire, anche solo parzialmente, i componenti dei sistemi illustrati in questo folder, senza l'obbligo di darne preavviso.

The reproduction of colors is approximate. Skema S.p.A. has the exclusive right to modify and replace, even only partially, the components of the systems illustrated in this folder, without the obligation to give prior notice.

© Copyright by Skema S.p.A.
All rights reserved

