

SKEMA

INDOOR STAR KS
PAVIMENTI IN SPC SPC FLOORING



SKEMA

Superfici da vivere, dal 1992
Living surfaces, since 1992

PAVIMENTI IN SPC

SPC FLOORING

I pavimenti in SPC sono realizzati in materiale minerale riciclabile, polimeri e additivi che creano grande stabilità, resistenza all'acqua, ai graffi e alle variazioni termiche. Sono proposti con decori che riproducono il legno, il marmo, il metallo e la resina.

Per le loro caratteristiche fisiche, meccaniche ed estetiche, sono ideali per ambienti domestici, direzionali e commerciali.

In base alle esigenze di impiego possono essere provvisti di materassini fonoimpedenti, per un eccellente isolamento acustico.

SPC flooring is made from recyclable mineral materials, polymers, and additives that ensure excellent dimensional stability, resistance to water, scratches, and thermal variations. The collections feature décors inspired by wood, marble, metal, and resin.

Thanks to their physical, mechanical, and aesthetic properties, these floors are ideal for residential, office, and commercial spaces.

Depending on application requirements, they can be supplied with sound-absorbing underlays for excellent acoustic insulation.



“Pavimenti evoluti che combinano prestazioni tecniche, estetica e facilità di posa.”

“Advanced flooring solutions that combine technical performance, refined aesthetics, and ease of installation.”

Star KS

**L'eleganza della spina francese
e le prestazioni dell'SPC.**

The elegance of the French
herringbone pattern and the
performance of SPC.

Star KS unisce l'eleganza della posa a spina francese con le prestazioni avanzate di un pavimento SPC, creando un equilibrio perfetto tra tradizione e innovazione. Grazie alla tecnologia Endless, la superficie assicura un effetto continuo e uniforme, valorizzando il disegno senza interruzioni visive.

I suoi punti di forza sono lo spessore ridotto di soli 6 mm, che lo rende ideale anche per ristrutturazioni, il micro bisello sui quattro lati che definisce le geometrie con precisione e la superficie resistente all'acqua, caratteristica che permette di utilizzare il pattern a spina di pesce in contesti dove il parquet tradizionale non può essere impiegato.

Star KS rende possibile portare la bellezza della spina francese in ambienti pubblici e ad alto traffico, garantendo al tempo stesso praticità di posa, durabilità ed elevato livello estetico.

Star KS combines the elegance of the French herringbone installation with the advanced performance of SPC flooring, achieving a perfect balance between tradition and innovation. Thanks to Endless technology, the surface delivers a continuous and seamless visual effect, enhancing the pattern without interruptions.

Its key strengths include a reduced thickness of just 6 mm, ideal even for renovation projects; micro-beveling on all four sides, which precisely defines the geometry of each plank; and a water-resistant surface that allows the use of the herringbone pattern in spaces where traditional parquet would not be suitable.

Star KS brings the timeless beauty of the French herringbone design to public and high-traffic environments, while ensuring ease of installation, durability, and refined aesthetics.



Product
Star KS - Nantes 1227

NANTES/ 1227

emotion

1498x300x6 mm

MARSIGLIA/ 1228

emotion

1498x300x6 mm

Dati tecnici Technical data

STRATIGRAFIA/ STRATIGRAPHY

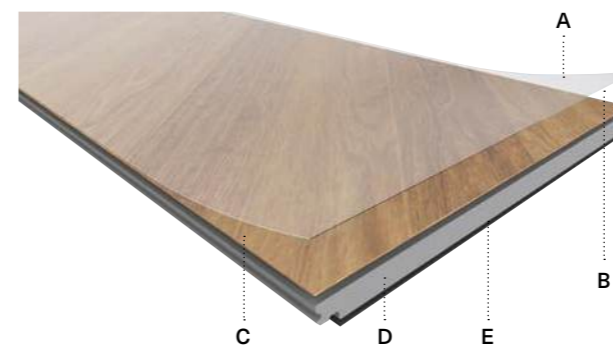

- A. Rivestimento anti-UV**
Anti-UV Coating
- B. Strato protettivo "Shell Star"**
Protective "Shell Star" layer
- C. Film vinilico decorativo**
Vinyl decorative film
- D. Cor.Star pannello in tecnologia SPC**
Cor.Star panel in SPC technology
- E. Sottopavimento acustico IXPE**
IXPE acoustic underlayer

FORMATI/ FORMATS

Star KS
1498x300x6 mm



CARATTERISTICHE TECNICHE/ TECHNICAL FEATURES

| | | | | | |
|---|--|-----------------|--|--|---|
| Incastro Joint | | 5G™ | Strato di usura Wear layer | | 0.55 mm |
| Bisello Bevel | | Micro 4v | Uso domestico Domestic use | | 23 Alto Traffico High Traffic |
| Sincroporo Synchropores | | √ ** | Uso commerciale Commercial use | | 33 Alto Traffico High Traffic |
| Reazione al fuoco* Fire reaction* | | Bfl-s1 | Scivolosità Slipperiness | | DS |
| Riscaldamento a pavimento Radiant heating | | T ≤ 28°C | | | |

* Classificazione valida con l'utilizzo dei sottopavimenti e/o modalità indicate da Skema S.p.A. (per dettagli vedi scheda tecnica del prodotto e/o istruzioni per l'installazione).
* Classification valid with the use of underlayer and/or modality specified by Skema S.p.A. (please see product technical data sheet and/or installation instructions for details).

** Tecnologia Endless: il disallineamento dei biselli impressi non è da considerarsi un difetto ma un aspetto del prodotto.
** Endless Technology: misalignment of the imprinted bevels is not to be considered a defect but an aspect of the product.

ACCESSORI/ ACCESSORIES

| | |
|-------------------------------------|--|
| Sottopavimenti Underlayer | Integrato in IXPE*** IXPE integrated*** |
| Profilo Profile | Kit dislivello, kit dilatazione, kit terminale Splice kit, expansion kit, terminal kit |
| Battiscopa Skirting board | PVC Espanso Expanded PVC |

*** Skema indica di posare sempre la barriera vapore.
*** Skema indicates to always lay the vapor barrier.

SPECIFICHE E CONFORMITÀ/ SPECIFICATIONS AND COMPLIANCE



CONFEZIONAMENTO/ PACKAGING

| Rif. formato/ Size | Pezzi Cfz/ Pieces Box | m ² Cfz/ Box | Cfz Pallet/ Box Pallet | m ² Pallet |
|--------------------|-----------------------|-------------------------|------------------------|-----------------------|
| 1498x300 mm | 6 | 2,696 | 42 | 113,250 |

010

ACCESSORI
ACCESSORIES

Sottopavimenti Underlayers

SUPERIOR RBR



Alte performance; densità media 800 kg/m³; soddisfa lo standard EPLF; ottima resistenza meccanica CS a protezione dell'incastro; alta performance acustica IS per riduzione riverbero in stanza RWS; bassa resistenza termica TR, consigliato per posa su massetti radianti; barriera vapore integrata (PET/Alu); bassissima emissione VOC; posa lato PET/Alluminio verso l'alto.

High performance; average density 800 kg/m³; fulfils EPLF standards; excellent mechanical resistance CS to protect the joint; high acoustic performance IS for room reverberation reduction RWS; low thermal resistance TR, recommended for laying on radiant screeds; integrated vapour barrier (PET/Alu); very low VOC emission; PET/Alu side up laying.

Dimensioni
Size

Rotolo/ Roll 8x1 m
Sp. 2 mm | D 800 kg/mc

BARRIERA VAPORE BN MOISTURE BARRIER BN



Foglio in polietilene coestruso ultrasottile, con uno spessore di 10 micron. La funzione principale è creare una barriera antivapore, proteggendo il pavimento dall'umidità che potrebbe risalire dagli elementi costruttivi. È facile da posare e rappresenta una soluzione efficace per mantenere il pavimento asciutto e duraturo.

Ultra-thin co-extruded polyethylene sheet, 10 microns thick. Its main function is to act as a vapor barrier, isolating the floor and protecting it from moisture rising from adjacent structural elements. This product is easy to install, and provides an effective solution for keeping floors dry and long-lasting.

Dimensioni
Size

Rotolo/ Roll da 30 mq - 25x1,2 m
Sp.100 my | D 0,93g/cm³
Rotolo/ Roll da 60 mq - 50x1,2 m
Sp.100 my | D 0,93g/cm³
Rotolo/ Roll da 120 mq - 100x1,2 m
Sp.100 my | D 0,93g/cm³

Battiscopa Skirting boards

STAR



Battiscopa in HDF con proporzioni standard.
HDF skirting board with standard proportions.

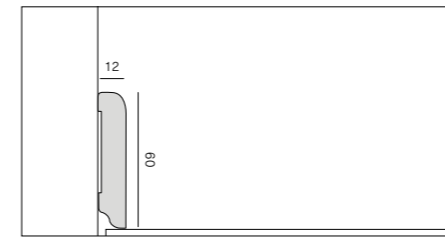

TIME



Battiscopa in HDF.
Skirting board made of HDF.

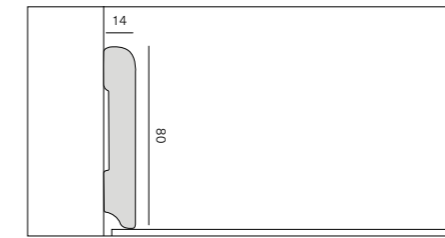

LOOK

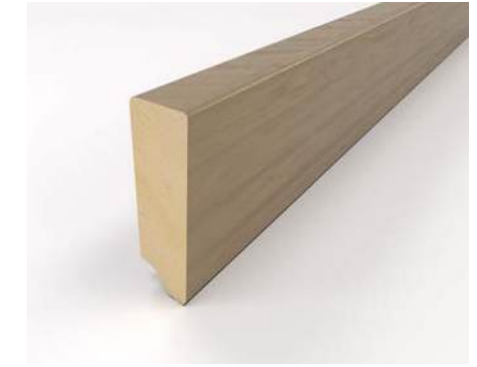

Battiscopa in HDF con finitura poro.
Skirting board made of HDF with a pore finish.

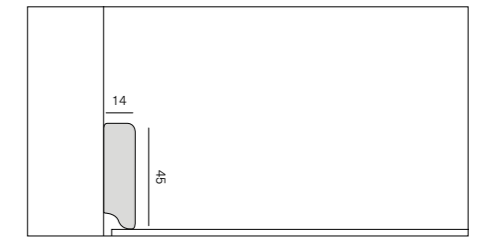

ABACO / RECAP

| | STAR | TIME | LOOK |
|------------------------------------|----------------------------|--|---|
| Abbinati Matching | Facile+ | Prestige L Prestige Gold | Prestige L Prestige Gold Vision Technic |
| Abbinabili Combined | Syncro Parquet | Lumbertech | - |
| Tinta unita Solid colors | ○ Bianco opaco/ Matt white | ○ Bianco lucido/ Glossy white ○ Bianco opaco/ Matt white ○ Grigio chiaro/ Light grey ● Grigio medio/ Medium grey ● Grigio scuro/ Dark grey ● Nero opaco/ Matt black ● Carbonio/ Carbon ○ Beige ○ Avorio/ Ivory ● Metallo bronzo/ Bronze metal | ● Alluminio/ Aluminum ○ Bianco lucido/ Glossy white ○ Bianco opaco/ Matt white ○ Grigio chiaro/ Light grey ● Grigio medio/ Medium grey ● Grigio scuro/ Dark grey ● Nero opaco/ Matt black ● Carbonio/ Carbon ○ Beige ○ Avorio/ Ivory ● Metallo bronzo/ Bronze metal |
| Dimensioni Size | h 60-2400x12 mm | h 80-2400x14 mm | h 45-2400x14 mm h 45-2200x14 mm |

DROP



Battiscopa in HDF a bassa assorbenza con finiture poro. Con densità di 700 kg/m³ offre alta resistenza all'umidità.
HDF skirting board with low absorbency and a sealed finish. Its 700 kg/m³ density ensures high moisture resistance.

PVC ESPANSO

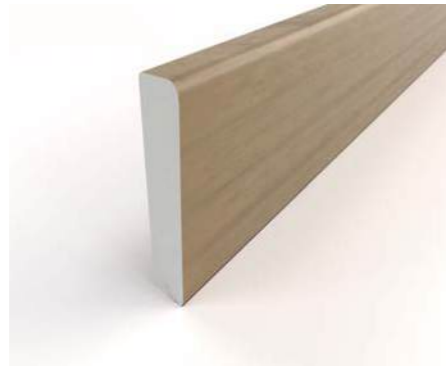

Battiscopa in PVC espanso resistente all'umidità.
Moisture-resistant expanded PVC skirting board.

F



Battiscopa realizzato con sistema folding utilizzando le relative doghe del pavimento.
Skirting board made with a folding system using the matching floor planks.

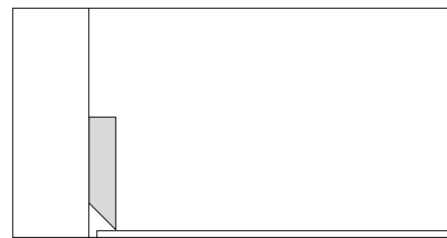
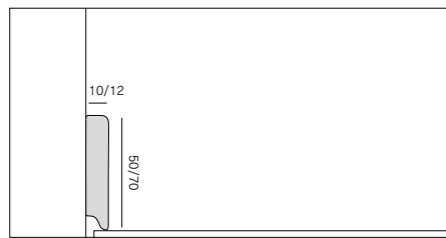
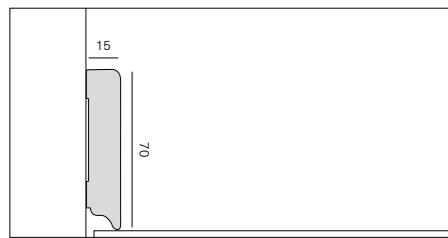

ABACO / RECAP

| | DROP | PVC ESPANSO | F |
|------------------------------------|----------------------------------|---|---------------------|
| Abbinati Matching | K-Uno | Star K Star KR Star KC Star KD Connex | Yes |
| Abbinabili Combined | - | Star KS Star Wood Star Wood Spina | - |
| Tinta unita Solid colors | ○ Bianco/ White - RAL 9003, 9010 | ○ Bianco/ White - RAL 9003, 9010 ● Nero/ Black ● Alluminio/ Aluminum - RAL 9006 | - |
| Dimensioni Size | h 70-2400x15 mm | h 50-2400x12 mm h 70-2400x12 mm | Variabile/ Variable |

W45



Profilo per battiscopa realizzato in MDF rivestito di tranciato di vero legno con finiture verniciate a poro aperto (gruppo 1) e, per i colorati, con stampa digitale successivamente verniciato (gruppo 2).
Skirting board profile made of MDF and covered with real wood veneer. Two types of finishings available: open pore varnished finishing (group 1) and a coloured finishing made by digital printing process and then varnished (group 2).

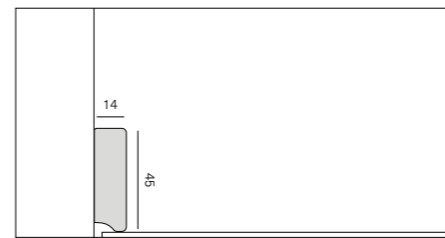

W75



Profilo per battiscopa realizzato in MDF rivestito di tranciato di vero legno con finiture verniciate a poro aperto (gruppo 1) e, per i colorati, con stampa digitale successivamente verniciato (gruppo 2).
Skirting board profile made of MDF and covered with real wood veneer. Two types of finishings available: open pore varnished finishing (group 1) and a coloured finishing made by digital printing process and then varnished (group 2).

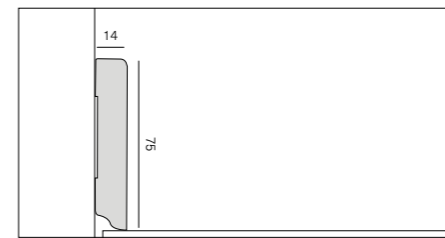

ABACO / RECAP

| | W45 | W75 |
|-------------------------------|-----------------|-----------------|
| Abbinabili Combined | Palladio Yes | Palladio Yes |
| Dimensioni Size | h 45-2400x14 mm | h 75-2400x14 mm |

Profili

Profiles

PARAGRADINO ANTISDRUCCIOLO
NO-SLIP STAIR PROTECTOR



Paragradino antisdrucchioLO in alluminio, che consente di rivestire il raccordo tra alzata e pedata di una scala.

Acquistare sempre con antiscivolo autoadesivo.
Non-slip aluminum stair nosing, used to cover the transition between the riser and tread of a staircase. Always purchase with self-adhesive non-slip tape.

ANGOLARE AD L
L-SHAPED CORNER PROFILE

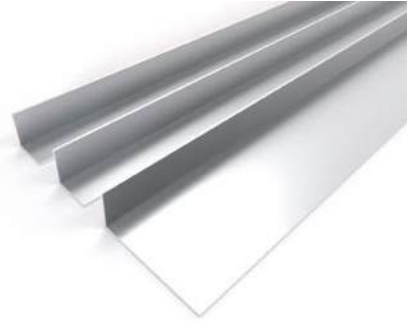

Profilo in alluminio per finiture di raccordi a muro.

Aluminium profile for finishing wall connections.

PROFILO DI BORDO
BORDER PROFILE

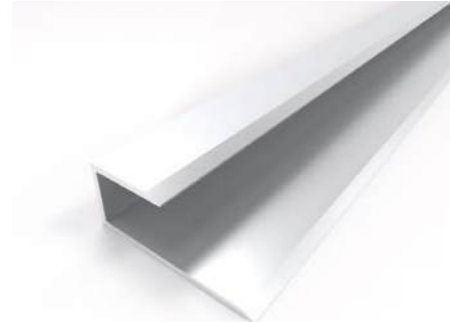

Profilo in alluminio estruso per bordature perimetrali per pavimenti.

Extruded aluminium profile for perimeter edging of floors.

PROFILO DI BORDO CURVABILE
CURVABLE BORDER PROFILE



Profilo in alluminio estruso curvabile per bordature perimetrali.

Extruded curvable aluminium profile for perimeter edging.

PROFILO SCALA SINTESY
SINTESY STAIR PROFILE



Profilo scala in alluminio anodizzato argento, per rivestire i gradini con le stesse doghe utilizzate per realizzare il pavimento.

Anodized Silver anodized aluminum profile to cover the steps with the same planks used for the flooring.

KIT DILATAZIONE DA 5 A 7 MM
EXPANSION KIT 5 TO 7 MM



Kit dilatazione in alluminio per pavimenti con spessore da 5 a 7 mm, con base femmina in PVC.

Aluminum expansion kit for floorings with thickness from 5 to 7 mm and PVC female base.

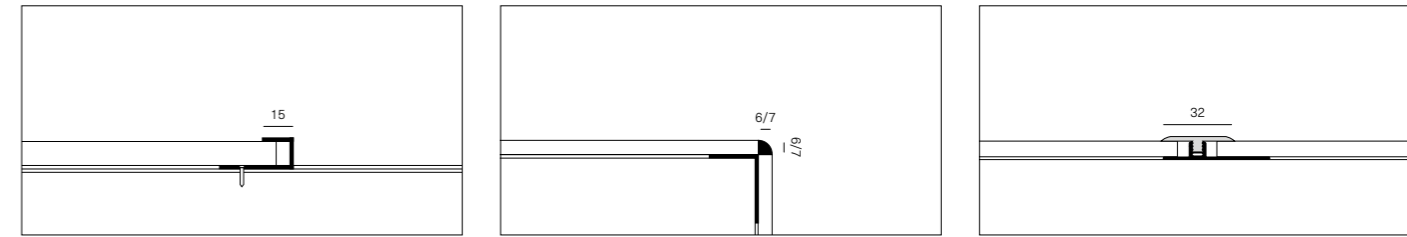
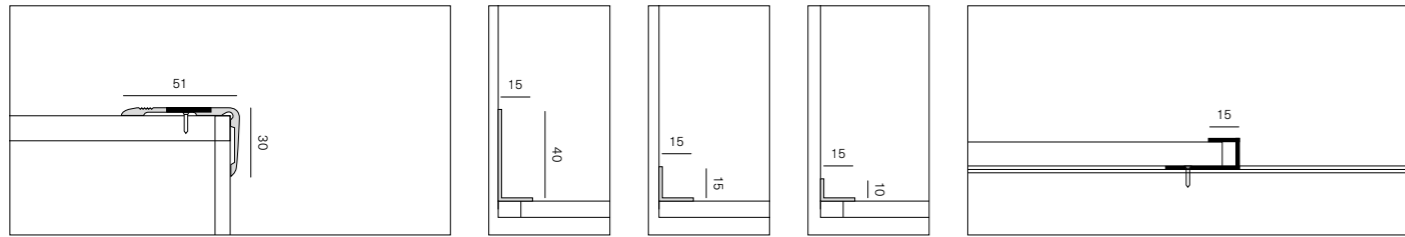

ABACO / RECAP

| | PARAGRADINO ANTISDRUCCIOLO NO-SLIP STAIR PROTECTOR | ANGOLARE AD L L-SHAPED CORNER PROFILE | PROFILO DI BORDO BORDER PROFILE |
|------------------------------------|--|--|--|
| Collezioni Lines | Pavimenti tecnici/ Technical flooring SPC Legni/ Wood | Pavimenti tecnici/ Technical flooring SPC Legni/ Wood | Pavimenti tecnici/ Technical flooring SPC Legni/ Wood |
| Tinta unita Solid colors | ● Argento anodizzato/ Anodized silver ● Oro anodizzato/ Anodized gold ● Bronzo anodizzato/ Anodized bronze | ● Argento/ Silver ● Bronzo/ Bronze | ● Argento/ Silver ● Oro/ Gold |
| Dimensioni Size | 3400x52x30 mm 18 m rotolo striscia antiscivolo autoadesiva/ 18 m roll self-adhesive non-slip strip | ● 2000/3000x15x10 mm spessore 1,0 mm/ 1.0 mm thick ● 2000x15x15 mm spessore 1,5 mm/ 1.5 mm thick ● 2000x45x40 mm spessore 2,0 mm/ 2.0 mm thick | 2700x15x6 mm 2700x15x7 mm 2700x15x9 mm 2700x15x11 mm 2700x15x15 mm |

ABACO / RECAP

| | PROFILO DI BORDO CURVABILE CURVABLE BORDER PROFILE | PROFILO SCALA SINTESY SINTESY STAIR PROFILE | KIT DILATAZIONE DA 5 A 7 MM EXPANSION KIT 5 TO 7 MM |
|--|---|---|--|
| Collezioni Lines | Pavimenti tecnici/ Technical flooring SPC Legni/ Wood | SPC | SPC |
| Collezioni abbinata Matching lines | - | - | Star K Star KR Star KC Star KS Star KD Connex |
| Abbinabili Combined | - | - | Star KS Star Wood Star Wood Spina |
| Tinta unita Solid colors | ● Argento/ Silver ● Oro/ Gold ● Bronzo/ Bronze | ● Argento/ Silver | ● Argento anodizzato/ Anodized silver |
| Dimensioni Size | Pavimenti tecnici/ Technical flooring ● 2700x15x9 mm - 2700x15x11 mm SPC ● 2700x15x7 mm Legni/ Wood ● 2700x15x11 mm ● 2700x15x13 mm - 2700x15x15 mm | 2700x6 mm Star Wood - Star Wood Spina 2700x7 mm | 2700x32 mm |

DILATAZIONE SINTESY
SINTESY EXPANSION



Profilo di dilatazione in alluminio anodizzato argenteo autoadesivo.
Self-adhesive silver anodized aluminium expansion profile.

DISLIVELLO SINTESY
SINTESY SPLICE PROFILE



Profilo di dislivello in alluminio anodizzato autoadesivo per pavimenti con spessore da 4 a 6 mm.
Self-adhesive anodized aluminium transition profile for 4-6 mm floors.

KIT DISLIVELLO DA 5 A 7 MM
SPLICE KIT 5 TO 7 MM



Kit dislivello in alluminio o abbinato per pavimenti con spessore da 5 a 7 mm con base femmina in PVC.
Aluminum splice or matching kit for floorings with thickness from 5 to 7 mm, with PVC female base.

KIT TERMINALE DA 5 A 7 MM
TERMINAL KIT FROM 5 TO 7 MM



Kit terminale in alluminio per pavimenti con spessore da 5 a 7 mm con base femmina in PVC.
Aluminium end kit for floors with thickness from 5 to 7 mm, with PVC female base.

SISTEMA FOLDING PER SPC
FOLDING SYSTEM FOR SPC



L'elemento "folding" si presenta con una piega a 90°, adatto per rivestire scalini ad angolo retto.
Solo per residenziale.
The "folding" element has a 90° bend, suitable for covering right-angled steps.
For residential use only.

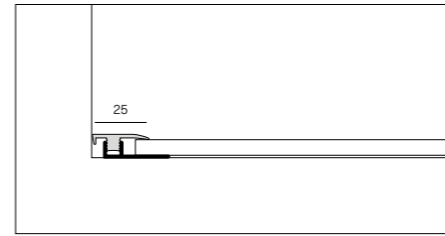
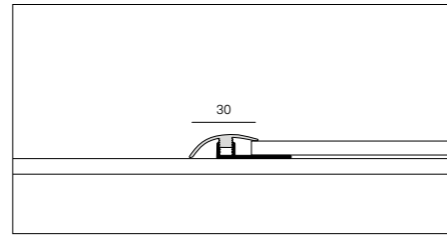
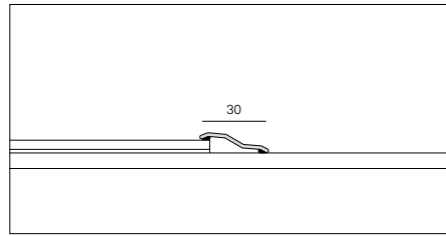
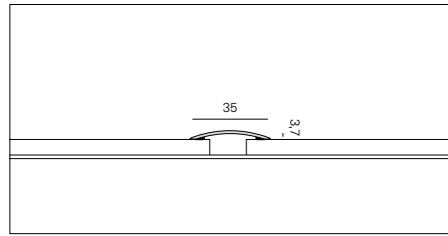

ABACO / RECAP

| | DILATAZIONE SINTESY SINTESY EXPANSION | DISLIVELLO SINTESY SINTESY SPLICE PROFILE | KIT DISLIVELLO DA 5 A 7 MM SPLICE KIT 5 TO 7 MM |
|------------------------------------|--|--|--|
| Collezioni Lines | SPC | - | - |
| Abbinati Matching | - | Star K Star KR Star KC Star KS Star KD Connex | Star K Star KR Star KC Star KD |
| Abbinabili Combined | - | - | Star KS |
| Tinta unita Solid colors | ● Argento satinato/ Satin silver | ● Argento anodizzato/ Anodized silver | ● Argento anodizzato/ Anodized silver |
| Dimensioni Size | 2700x35 mm | 2700x29 mm | 2700x30 mm |

ABACO / RECAP

| | KIT TERMINALE DA 5 A 7 MM TERMINAL KIT FROM 5 TO 7 MM | SISTEMA FOLDING PER SPC FOLDING SYSTEM FOR SPC |
|------------------------------------|--|--|
| Collezioni Lines | - | Star KD Star K Star KR Star KS Star KC Star KW |
| Abbinati Matching | SPC | - |
| Tinta unita Solid colors | ● Argento anodizzato/ Anodized silver | - |
| Dimensioni Size | 2700x25 mm | Dimensione dogia piegata (lunghezza x pedata x alzata) Folded plank size (length x tread x riser) Star KD 914x375x76 mm Star K 1828x140x72 mm Star KR 1500x140x74 mm 1828x150x72 mm Star KC 1500x148x74 mm Star KW Su richiesta/ On demand |

Posa Laying

KIT MORSETTI TELESCOPICI TELESCOPIC CLAMP KIT



In fase di partenza il muro non è mai regolare. I morsetti permettono di registrare la distanza tra muro e pavimento in senso longitudinale, accelerando le fasi di posa di un pavimento flottante. Consigliati 2 kit per posatore.

When starting, walls are never perfect. These clamps allow you to register the horizontal distance between the wall and the flooring, for more rapid installation. 2 kits per installer are recommended.

Collezioni
Lines

Pavimenti tecnici/
Technical flooring
Legni/ Wood

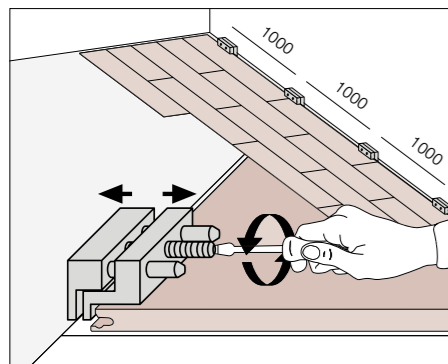

GRIMALDELLO PICKLOCK



È indispensabile per completare l'ultima fila di pavimento, in quanto non c'è spazio per la manovra del martello. Solo per incastri SLS e PLS (no TLS). Consigliati 1 pezzo per posatore.

This tool is required for finishing the last row of the flooring as there is no place enough for using the hammer.

We recommend 1 tool per installer.

Collezioni
Lines

Pavimenti tecnici/
Technical flooring
Legni/ Wood

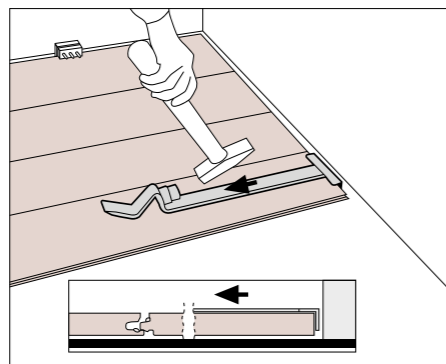

TENSIONATORE CINGHIA BELT TENSIONER



Per pavimenti con incastro a colla. Strumento per compattare le prime tre/ quattro file di doghe, fondamentali per la buona riuscita del lavoro soprattutto con colori chiari su incastri tradizionali a colla.

For floorings with glued joints. Used to compact the first three or four rows of planks. Fundamental for good installation, especially for light colours with traditional glued joints. 6 units per installer are recommended.

Collezioni
Lines

Pavimenti tecnici/
Technical flooring
Legni/ Wood

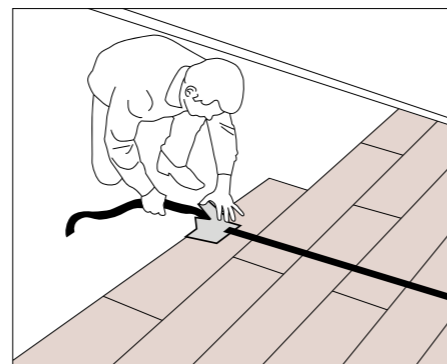

DISTANZIATORE PER PAVIMENTI FLOTTANTI SPACER FOR FLOATING FLOORING



Nei casi in cui si debba fissare al pavimento elementi di arredo o funzionali, consente di evitare il bloccaggio delle dilatazioni del pavimento e conseguenti sollevamenti dello stesso.

If you need to fasten pieces of furniture or functional elements to the flooring, it avoids blocking the flooring expansion and its consequent raising.

Collezioni
Lines

Pavimenti tecnici/
Technical flooring

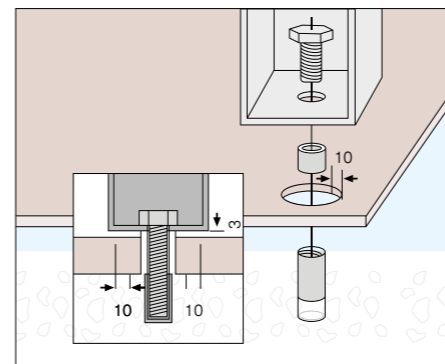

DISTANZIATORE PER PAVIMENTI AV2 AV2 SPACER FOR FLOORING



Distanziatore in plastica per pavimenti flottanti, regolabile 5-20 mm.

Plastic spacer for floating floors, adjustable 5-20 mm.

Collezioni
Lines

Pavimenti tecnici/
Technical flooring
Legni/ Wood

BATTITAVOLA PAVIMENTI TECNICI TECHNICAL FLOORING STAVES ALIGNER



Indispensabile per raccordare le doghe. Consigliato 1 pezzo per posatore.

Avvertenza: Usare esclusivamente battitavola originali per evitare di danneggiare l'incastro in modo irreparabile.

Indispensable for aligning the edge of the panels. We recommend 1 tool per installer. Notice: Use only original Staves Aligner to avoid irreparable damages to the joint.

Collezioni
Lines

Pavimenti tecnici/
Technical flooring

ACCESSORI DI MONTAGGIO INSTALLATION ACCESSORIES



Accessori complementari utili per un lavoro preciso e veloce. Accessories complementary for accurate, rapid installation.

Collezioni
Lines

Pavimenti tecnici/
Technical flooring

COLLA NUNIVIL 1008 (D3)
GLUE NUNIVIL 1008 (D3)



Adesivo acetovinilico per pavimenti flottanti con incastro M/F. Consumo medio 35–40 g/m². Consultare la documentazione tecnica sul sito.
Special vinyl adhesive for floating floors with M/F joint. Average consumption 35–40 g/m². Refer to the technical documentation on the website.

| | |
|-------------------------|---|
| Collezioni Lines | Pavimenti tecnici/ Technical flooring Legni/ Wood |
| Confezione Packaging | 500 gr |

**COLLA ISOCOLL 6307 BEIGE
PER BATTISCOPA PVC ESPANSO**
GLUE ISOCOLL 6307 BEIGE
FOR EXPANDED PVC SKIRTING BOARDS



Colla poliuretanica monocomponente per un ottimo fissaggio del battiscopa in PVC espanso su diverse superfici.
Single component polyurethane adhesive for excellent fastening of expanded PVC skirting board on different surfaces.

| | |
|-------------------------|--------|
| Collezioni Lines | SPC |
| Confezione Packaging | 290 ml |

**COLLA ISOCOLL ECO 6056 BIANCO
PER SCALE BATTISCOPA**
GLUE ISOCOLL ECO 6056 WHITE
FOR STEPS AND SKIRTING BOARDS



Colla monocomponente per il fissaggio del battiscopa e incollaggio gradini.
Single component adhesive for fastening skirting and stair elements.

| | |
|-------------------------|---|
| Collezioni Lines | Pavimenti tecnici/ Technical flooring Legni/ Wood |
| Confezione Packaging | 290 ml |

WAX CARE SPRAY



Wax care è una dispersione di cere idrorepellenti per la protezione di pavimenti in legno verniciati o oliati.
Wax care is a dispersion of water-repellent waxes for protection of varnished or oiled wooden floors.

| | |
|-------------------------|---|
| Collezioni Lines | Star Wood Star Wood Spina Legni/ Wood |
| Confezione Packaging | - |

PARKETTREINIGER



Detergente per parquet a base di sapone naturale, pH neutro, ideale per la pulizia periodica di pavimenti in legno verniciati o oliati.
Parquet cleaner, natural soap-based, pH-neutral, ideal for regular cleaning of varnished or oiled wooden floors.

| | |
|-------------------------|---------------------------------------|
| Collezioni Lines | Lumbertech 270 Oil Palladio Yes |
| Confezione Packaging | 1 L |

DETERGENTE MANUTENTORE CEROSO
WAXY MAINTENANCE CLEANER



Prodotto di manutenzione trasparente a base di cere naturali per il rinnovo ciclico dei pavimenti in legno.
Transparent maintenance product based on natural waxes for the cyclical renewal of wooden floors.

| | |
|-------------------------|---------------------------------------|
| Collezioni Lines | Lumbertech 270 Oil Palladio Yes |
| Confezione Packaging | 1 L |

Cura e manutenzione

Care and maintenance

PULISYSTEM



Detergente igienizzante.
Sanitizing detergent.

| | |
|-------------------------|---|
| Collezioni Lines | Pavimenti tecnici/ Technical flooring Lumbertech SPC |
| Confezione Packaging | 1 L |

SANITOTAL



Detergente decontaminante.
Attenzione: da utilizzarsi dopo aver lavato le superfici con il prodotto pulisystem.
Decontaminant detergent.
Warning: use only after cleaning surfaces with Pulisystem.

| | |
|-------------------------|---|
| Collezioni Lines | Pavimenti tecnici/ Technical flooring Lumbertech SPC |
| Confezione Packaging | 1 L |

MULTILAYER CLEANER



Detergente antistatico sanificante adatto alla pulizia di pavimenti tecnici e vinilici.
Antistatic sanitizing cleaner for technical and vinyl flooring.

| | |
|-------------------------|---|
| Collezioni Lines | Pavimenti tecnici/ Technical flooring SPC |
| Confezione Packaging | 1 L |

OLIO PER RITOCO
RETOUCHING OIL



Olio per ritocco e ripristino.
Touch-up and restoration oil.

| | |
|-------------------------|--------------------|
| Collezioni Lines | Lumbertech 270 Oil |
| Confezione Packaging | 0,125 L |

CLEANER STAR



Detergente intensivo multiuso per la pulizia di pavimenti in legno verniciati/ olio UV.
Intensive multipurpose cleaner for varnished and UV-oiled wooden floors.

| | |
|-------------------------|--|
| Collezioni Lines | Lumbertech 270 Varnish, 205, S700 Palladio |
| Confezione Packaging | - |

OSMO POLYX OIL 3062 MATT



Trattamento speciale di oliatura.
Special oiling treatment.

| | |
|-------------------------|--------------------|
| Collezioni Lines | Lumbertech 270 Oil |
| Confezione Packaging | - |

**PACKAGING
E LOGISTICA**
PACKAGING
AND LOGISTICS

Pavimenti in SPC

SPC flooring

| Prodotto Product | Rif. formato mm Size mm | Pezzi C fz Pieces Box | m ² C fz m ² Box | Dimensioni scatola mm Box dimensions mm | Kg per scatola Kg per box | C fz pallet Box pallet | m ² pallet m ² pallet | Dimensione pallet (mm) Pallet dimensions (mm) | Kg pallet al m ² Pallet kg per m ² | Peso lordo pallet Pallet Weight |
|---------------------|----------------------------|--------------------------|---|--|------------------------------|---------------------------|--|--|---|------------------------------------|
| STAR K | 1828x218x6 | 4 | 1,594 | 1860x240x30 | 17,14 | 68 | 108,452 | 1900x980x650 | 10,75 | 1181 |
| | | 6 | 2,392 | 1845x230x42 | 25,10 | 48 | 114,819 | 1870x1000x665 | 10,75 | 1260 |
| STAR KR | 1500x220x6 | 6 | 1,980 | 1531x242x30 | 20,96 | 56 | 110,880 | 1570x988x435 | 10,59 | 1189 |
| | 1828x228x6 | 4 | 1,668 | 1840x240x26 | 17,38 | 68 | 113,415 | 1865x1010x640 | 10,42 | 1205 |
| | 1828x218x6 | 6 | 1,594 | 1860x240x30 | 25,10 | 48 | 114,819 | 1870x1000x665 | 10,42 | 1230 |
| STAR KC | 1500x228x6 | 6 | 2,052 | 1525x240x40 | 21,16 | 52 | 106,704 | 1535x975x670 | 10,31 | 1145 |
| STAR KS | 1498x300x6 | 6 | 2,696 | 1530x322x40 | 29,12 | 42 | 113,249 | 1570x670x1000 | 10,8 | 1225 |
| STAR KD | 914x457x6 | 6 | 2,506 | 940x480x40 | 25,38 | 40 | 100,247 | 970x980x1000 | 10,12 | 1030 |
| CONNEX | 1500x180x5,5 | 8 | 2,16 | 1515x195x50 | 19,26 | 50 | 108 | 1540x1000x660 | 8,92 | 978 |
| STAR WOOD | 1218x165x7 | 8 | 1,607 | 1240x182x60 | 20,8 | 72 | 125,405 | 1250x1110x910 | 12,94 | 1642 |
| | 1900x190x7 | 6 | 2,166 | 1928x182x60 | 20,8 | 55 | 119,13 | 1930x1040x665 | 12,93 | 1560 |
| | 600x100x7 | 14 | 0,84 | 620x110x100 | 10,56 | 144 | 120,96 | 1250x930x970 | 12,57 | 1540 |

Skema S.p.A.

Via dell'Artigianato, 8
31047 Ponte di Piave (TV) - Italy

Ph. (+39) 0422 858511
info@skema.eu
www.skema.eu

A.D.

arch. paolo pampanoni

Concept & Graphic

d+a srl

Set design, rendering

virtual design
nudesign srl

Photo

studio antiorario

Printed

grafiche antiga

La riproduzione dei colori è approssimativa.

Skema S.p.A. ha la facoltà esclusiva di modificare e sostituire, anche solo parzialmente, i componenti dei sistemi illustrati in questo folder, senza l'obbligo di darne preavviso.

The reproduction of colors is approximate. Skema S.p.A. has the exclusive right to modify and replace, even only partially, the components of the systems illustrated in this folder, without the obligation to give prior notice.

© Copyright by Skema S.p.A.
All rights reserved

