

SKEMA

INDOOR STAR KD
PAVIMENTI IN SPC SPC FLOORING



SKEMA

Superfici da vivere, dal 1992
Living surfaces, since 1992

PAVIMENTI IN SPC

SPC FLOORING

I pavimenti in SPC sono realizzati in materiale minerale riciclabile, polimeri e additivi che creano grande stabilità, resistenza all'acqua, ai graffi e alle variazioni termiche. Sono proposti con decori che riproducono il legno, il marmo, il metallo e la resina.

Per le loro caratteristiche fisiche, meccaniche ed estetiche, sono ideali per ambienti domestici, direzionali e commerciali.

In base alle esigenze di impiego possono essere provvisti di materassini fonoimpedenti, per un eccellente isolamento acustico.

SPC flooring is made from recyclable mineral materials, polymers, and additives that ensure excellent dimensional stability, resistance to water, scratches, and thermal variations. The collections feature décors inspired by wood, marble, metal, and resin.

Thanks to their physical, mechanical, and aesthetic properties, these floors are ideal for residential, office, and commercial spaces.

Depending on application requirements, they can be supplied with sound-absorbing underlays for excellent acoustic insulation.



“Pavimenti evoluti che combinano prestazioni tecniche, estetica e facilità di posa.”

“Advanced flooring solutions that combine technical performance, refined aesthetics, and ease of installation.”

Star KD

Superfici materiche per spazi dal design innovativo.

Textured surfaces for spaces with innovative design.

Star KD è la collezione che reinterpreta in chiave contemporanea l'estetica di pietra, cemento e metallo, offrendo al tempo stesso le prestazioni tecniche avanzate di un pavimento in SPC. Proposto nel formato tile, definisce gli spazi con un linguaggio moderno e un carattere deciso.

I suoi punti di forza risiedono nella ricca varietà di decorativi materici, che spaziano tra tonalità e finiture capaci di soddisfare i gusti più attuali; nella superficie impermeabile, che assicura massima praticità e versatilità d'uso e nella piacevole sensazione di calore al calpestio, tipica dei pavimenti SPC. Con Star KD, l'effetto materico incontra comfort e funzionalità, dando vita a una soluzione ideale per ambienti contemporanei che ricercano alte performance tecniche senza rinunciare al benessere abitativo.

Star KD is the collection that reinterprets the aesthetics of stone, concrete, and metal in a contemporary way, while offering the advanced technical performance of SPC flooring. Presented in a tile format, it defines spaces with a modern and distinctive character. Its key strengths include a wide range of textured décors, featuring tones and finishes designed to meet the most current design trends; a waterproof surface that ensures maximum practicality and versatility of use; and the pleasant sense of warmth underfoot typical of SPC floors.

With Star KD, the material effect merges with comfort and functionality, creating the ideal solution for contemporary interiors that seek high technical performance without compromising on living comfort and style.



Product
Star KD - Cardiff 1209

BRUGES/ 1208

stone

914x457x6 mm

CARDIFF/ 1209

stone

914x457x6 mm

RESINA/ 1221

stone

914x457x6 mm

BARRY/ 1223

stone

914x457x6 mm

NEWPORT/ 1224

stone

914x457x6 mm

CORTEN/ 1225

stone

914x457x6 mm

Dati tecnici Technical data

STRATIGRAFIA/ STRATIGRAPHY

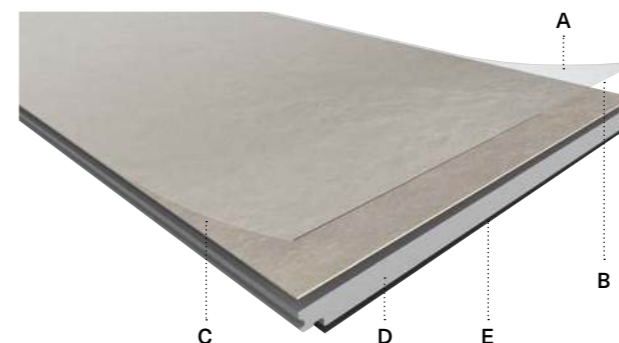

- A. Rivestimento anti-UV**
Anti-UV Coating
- B. Strato protettivo "Shell Star"**
Protective "Shell Star" layer
- C. Film vinilico decorativo**
Vinyl decorative film
- D. Cor.Star pannello in tecnologia SPC**
Cor.Star panel in SPC technology
- E. Sottopavimento acustico IXPE**
IXPE acoustic underlayer

FORMATI/ FORMATS

Star KD
914x457x6 mm



CARATTERISTICHE TECNICHE/ TECHNICAL FEATURES

Incastro Joint		5G™	Strato di usura Wear layer		0.55 mm
Bisello Bevel		Micro 4v	Uso domestico Domestic use		23 Alto Traffico High Traffic
Reazione al fuoco* Fire reaction*		Bfl-s1	Uso commerciale Commercial use		33 Alto Traffico High Traffic
Riscaldamento a pavimento Radiant heating		T ≤ 28°C	Scivolosità Slipperiness		DS

* Classificazione valida con l'utilizzo dei sottopavimenti e/o modalità indicate da Skema S.p.A. (per dettagli vedi scheda tecnica del prodotto e/o istruzioni per l'installazione).
* Classification valid with the use of underlayer and/or modality specified by Skema S.p.A. (please see product technical data sheet and/or installation instructions for details).

ACCESSORI/ ACCESSORIES

Sottopavimenti Underlayer	Integrato in IXPE** IXPE integrated**
Profilo Profile	Kit dislivello, kit dilatazione, kit terminale Splice kit, expansion kit, terminal kit
Battiscopa Skirting board	PVC Espanso Expanded PVC

** Skema indica di posare sempre la barriera vapore.
** Skema indicates to always lay the vapor barrier.

SPECIFICHE E CONFORMITÀ/ SPECIFICATIONS AND COMPLIANCE



CONFEZIONAMENTO/ PACKAGING

Rif. formato/ Size	Pezzi Cfz/ Pieces Box	m² Cfz/ Box	Cfz Pallet/ Box Pallet	m² Pallet
914x457 mm	6	2,506	40	100,335

ACCESSORI
ACCESSORIES

Sottopavimenti Underlayers

SUPERIOR RBR



Alte performance; densità media 800 kg/m³; soddisfa lo standard EPLF; ottima resistenza meccanica CS a protezione dell'incastro; alta performance acustica IS per riduzione riverbero in stanza RWS; bassa resistenza termica TR, consigliato per posa su massetti radianti; barriera vapore integrata (PET/Alu); bassissima emissione VOC; posa lato PET/Alluminio verso l'alto.

High performance; average density 800 kg/m³; fulfils EPLF standards; excellent mechanical resistance CS to protect the joint; high acoustic performance IS for room reverberation reduction RWS; low thermal resistance TR, recommended for laying on radiant screeds; integrated vapour barrier (PET/Alu); very low VOC emission; PET/Alu side up laying.

Dimensioni
Size

Rotolo/ Roll 8x1 m
Sp. 2 mm | D 800 kg/mc

BARRIERA VAPORE BN MOISTURE BARRIER BN



Foglio in polietilene coestruso ultrasottile, con uno spessore di 10 micron. La funzione principale è creare una barriera antivapore, proteggendo il pavimento dall'umidità che potrebbe risalire dagli elementi costruttivi. È facile da posare e rappresenta una soluzione efficace per mantenere il pavimento asciutto e duraturo.

Ultra-thin co-extruded polyethylene sheet, 10 microns thick. Its main function is to act as a vapor barrier, isolating the floor and protecting it from moisture rising from adjacent structural elements. This product is easy to install, and provides an effective solution for keeping floors dry and long-lasting.

Dimensioni
Size

Rotolo/ Roll da 30 mq - 25x1,2 m
Sp.100 my | D 0,93g/cm³
Rotolo/ Roll da 60 mq - 50x1,2 m
Sp.100 my | D 0,93g/cm³
Rotolo/ Roll da 120 mq - 100x1,2 m
Sp.100 my | D 0,93g/cm³

Battiscopa Skirting boards

STAR



Battiscopa in HDF con proporzioni standard.
HDF skirting board with standard proportions.

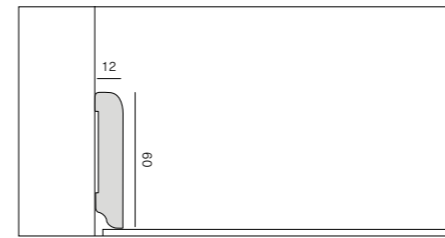

TIME



Battiscopa in HDF.
Skirting board made of HDF.

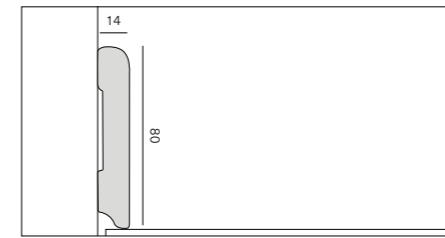

LOOK



Battiscopa in HDF con finitura poro.
Skirting board made of HDF with a pore finish.

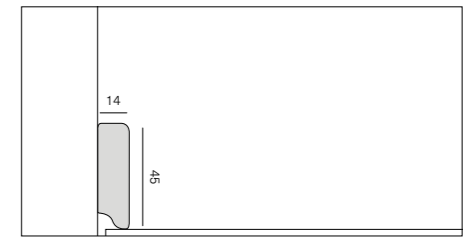

ABACO / RECAP

	STAR	TIME	LOOK
Abbinati Matching	Facile+	Prestige L Prestige Gold	Prestige L Prestige Gold Vision Technic
Abbinabili Combined	Syncro Parquet	Lumbertech	-
Tinta unita Solid colors	○ Bianco opaco/ Matt white	○ Bianco lucido/ Glossy white ○ Bianco opaco/ Matt white ○ Grigio chiaro/ Light grey ● Grigio medio/ Medium grey ● Grigio scuro/ Dark grey ● Nero opaco/ Matt black ● Carbonio/ Carbon ○ Beige ○ Avorio/ Ivory ● Metallo bronzo/ Bronze metal	● Alluminio/ Aluminum ○ Bianco lucido/ Glossy white ○ Bianco opaco/ Matt white ○ Grigio chiaro/ Light grey ● Grigio medio/ Medium grey ● Grigio scuro/ Dark grey ● Nero opaco/ Matt black ● Carbonio/ Carbon ○ Beige ○ Avorio/ Ivory ● Metallo bronzo/ Bronze metal
Dimensioni Size	h 60-2400x12 mm	h 80-2400x14 mm	h 45-2400x14 mm h 45-2200x14 mm

DROP



Battiscopa in HDF a bassa assorbenza con finiture poro. Con densità di 700 kg/m³ offre alta resistenza all'umidità.
 HDF skirting board with low absorbency and a sealed finish. Its 700 kg/m³ density ensures high moisture resistance.

PVC ESPANSO

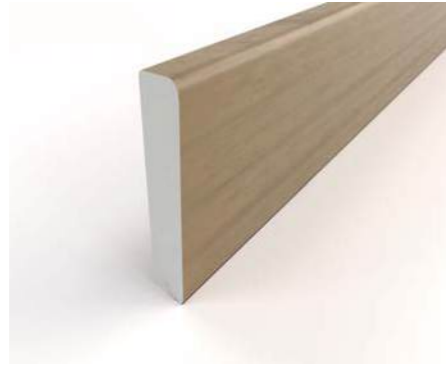

Battiscopa in PVC espanso resistente all'umidità.
 Moisture-resistant expanded PVC skirting board.

F



Battiscopa realizzato con sistema folding utilizzando le relative doghe del pavimento.
 Skirting board made with a folding system using the matching floor planks.

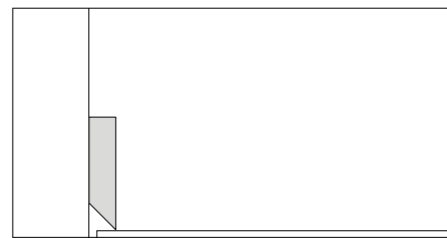
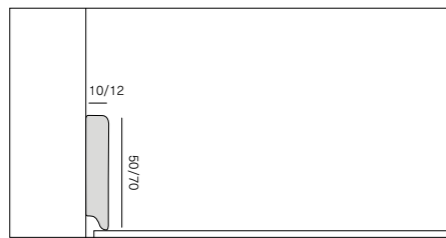
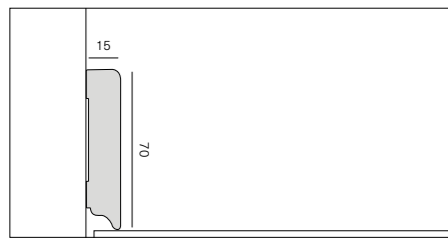

ABACO / RECAP

	DROP	PVC ESPANSO	F
Abbinati Matching	K-Uno	Star K Star KR Star KC Star KD Connex	Yes
Abbinabili Combined	-	Star KS Star Wood Star Wood Spina	-
Tinta unita Solid colors	○ Bianco/ White - RAL 9003, 9010	○ Bianco/ White - RAL 9003, 9010 ● Nero/ Black ● Alluminio/ Aluminum - RAL 9006	-
Dimensioni Size	h 70-2400x15 mm	h 50-2400x12 mm h 70-2400x12 mm	Variabile/ Variable

W45



Profilo per battiscopa realizzato in MDF rivestito di tranciato di vero legno con finiture verniciate a poro aperto (gruppo 1) e, per i colorati, con stampa digitale successivamente verniciato (gruppo 2).
 Skirting board profile made of MDF and covered with real wood veneer. Two types of finishings available: open pore varnished finishing (group 1) and a coloured finishing made by digital printing process and then varnished (group 2).

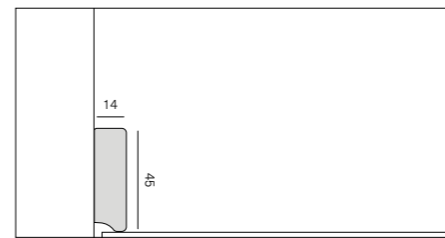

W75



Profilo per battiscopa realizzato in MDF rivestito di tranciato di vero legno con finiture verniciate a poro aperto (gruppo 1) e, per i colorati, con stampa digitale successivamente verniciato (gruppo 2).
 Skirting board profile made of MDF and covered with real wood veneer. Two types of finishings available: open pore varnished finishing (group 1) and a coloured finishing made by digital printing process and then varnished (group 2).

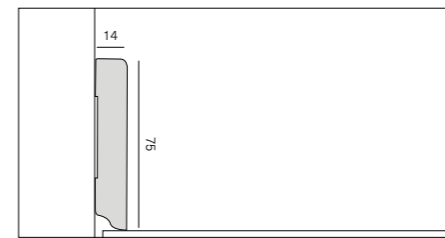

ABACO / RECAP

	W45	W75
Abbinabili Combined	Palladio Yes	Palladio Yes
Dimensioni Size	h 45-2400x14 mm	h 75-2400x14 mm

Profili

Profiles

PARAGRADINO ANTISDRUCCIOLO
NO-SLIP STAIR PROTECTOR



Paragradino antisdrucchio in alluminio, che consente di rivestire il raccordo tra alzata e pedata di una scala.
Acquistare sempre con antiscivolo autoadesivo.
Non-slip aluminum stair nosing, used to cover the transition between the riser and tread of a staircase. Always purchase with self-adhesive non-slip tape.

ANGOLARE AD L
L-SHAPED CORNER PROFILE

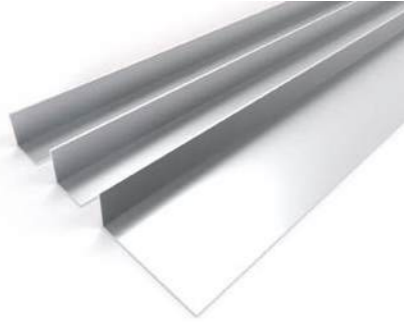

Profilo in alluminio per finiture di raccordi a muro.
Aluminium profile for finishing wall connections.

PROFILO DI BORDO
BORDER PROFILE

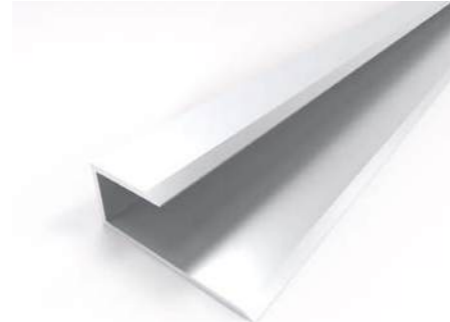

Profilo in alluminio estruso per bordature perimetrali per pavimenti.
Extruded aluminium profile for perimeter edging of floors.

PROFILO DI BORDO CURVABILE
CURVABLE BORDER PROFILE



Profilo in alluminio estruso curvabile per bordature perimetrali.
Extruded curvable aluminium profile for perimeter edging.

PROFILO SCALA SINTESY
SINTESY STAIR PROFILE



Profilo scala in alluminio anodizzato argento, per rivestire i gradini con le stesse doghe utilizzate per realizzare il pavimento.
Anodized Silver anodized aluminum profile to cover the steps with the same planks used for the flooring.

KIT DILATAZIONE DA 5 A 7 MM
EXPANSION KIT 5 TO 7 MM



Kit dilatazione in alluminio per pavimenti con spessore da 5 a 7 mm, con base femmina in PVC.
Aluminum expansion kit for floorings with thickness from 5 to 7 mm and PVC female base.

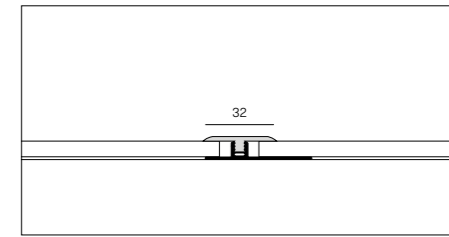
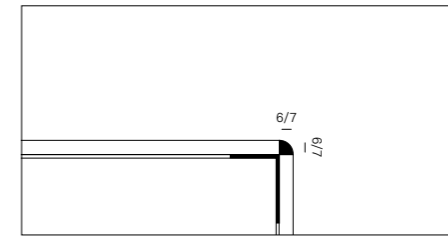
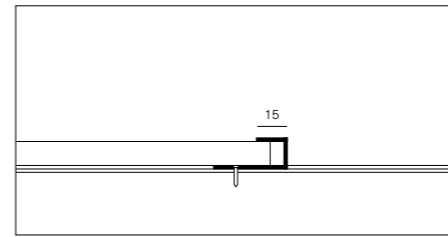
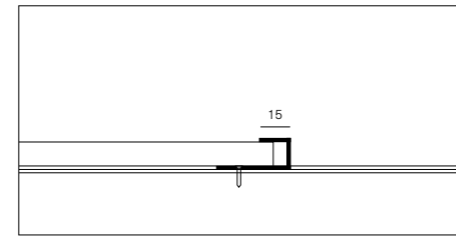
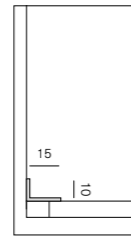
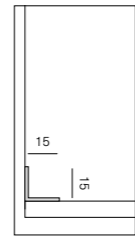
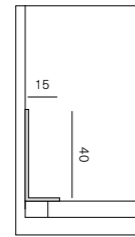
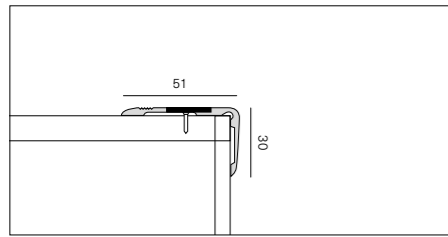

ABACO / RECAP

	PARAGRADINO ANTISDRUCCIOLO NO-SLIP STAIR PROTECTOR	ANGOLARE AD L L-SHAPED CORNER PROFILE	PROFILO DI BORDO BORDER PROFILE
Collezioni Lines	Pavimenti tecnici/ Technical flooring SPC Legni/ Wood	Pavimenti tecnici/ Technical flooring SPC Legni/ Wood	Pavimenti tecnici/ Technical flooring SPC Legni/ Wood
Tinta unita Solid colors	● Argento anodizzato/ Anodized silver ● Oro anodizzato/ Anodized gold ● Bronzo anodizzato/ Anodized bronze	● Argento/ Silver ● Bronzo/ Bronze	● Argento/ Silver ● Oro/ Gold
Dimensioni Size	3400x52x30 mm 18 m rotolo striscia antiscivolo autoadesiva/ 18 m roll self-adhesive non-slip strip	● 2000/3000x15x10 mm spessore 1,0 mm/ 1.0 mm thick ● 2000x15x15 mm spessore 1,5 mm/ 1.5 mm thick ● 2000x45x40 mm spessore 2,0 mm/ 2.0 mm thick	2700x15x6 mm 2700x15x7 mm 2700x15x9 mm 2700x15x11 mm 2700x15x15 mm

ABACO / RECAP

	PROFILO DI BORDO CURVABILE CURVABLE BORDER PROFILE	PROFILO SCALA SINTESY SINTESY STAIR PROFILE	KIT DILATAZIONE DA 5 A 7 MM EXPANSION KIT 5 TO 7 MM
Collezioni Lines	Pavimenti tecnici/ Technical flooring SPC Legni/ Wood	SPC	SPC
Collezioni abbinate Matching lines	-	-	Star K Star KR Star KC Star KS Star KD Connex
Abbinabili Combined	-	-	Star KS Star Wood Star Wood Spina
Tinta unita Solid colors	● Argento/ Silver ● Oro/ Gold ● Bronzo/ Bronze	● Argento/ Silver	● Argento anodizzato/ Anodized silver
Dimensioni Size	Pavimenti tecnici/ Technical flooring ● 2700x15x9 mm - 2700x15x11 mm SPC ● 2700x15x7 mm Legni/ Wood ● 2700x15x11 mm ● 2700x15x13 mm - 2700x15x15 mm	2700x6 mm Star Wood - Star Wood Spina 2700x7 mm	2700x32 mm

DILATAZIONE SINTESY
SINTESY EXPANSION



Profilo di dilatazione in alluminio anodizzato argenteo autoadesivo.
Self-adhesive silver anodized aluminium expansion profile.

DISLIVELLO SINTESY
SINTESY SPLICE PROFILE



Profilo di dislivello in alluminio anodizzato autoadesivo per pavimenti con spessore da 4 a 6 mm.
Self-adhesive anodized aluminium transition profile for 4-6 mm floors.

KIT DISLIVELLO DA 5 A 7 MM
SPLICE KIT 5 TO 7 MM



Kit dislivello in alluminio o abbinato per pavimenti con spessore da 5 a 7 mm con base femmina in PVC.
Aluminum splice or matching kit for floorings with thickness from 5 to 7 mm, with PVC female base.

KIT TERMINALE DA 5 A 7 MM
TERMINAL KIT FROM 5 TO 7 MM



Kit terminale in alluminio per pavimenti con spessore da 5 a 7 mm con base femmina in PVC.
Aluminium end kit for floors with thickness from 5 to 7 mm, with PVC female base.

SISTEMA FOLDING PER SPC
FOLDING SYSTEM FOR SPC



L'elemento "folding" si presenta con una piega a 90°, adatto per rivestire scalini ad angolo retto.
Solo per residenziale.
The "folding" element has a 90° bend, suitable for covering right-angled steps.
For residential use only.

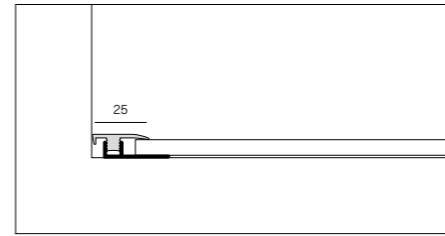
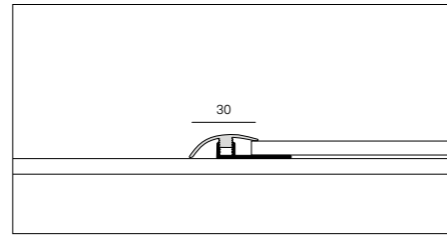
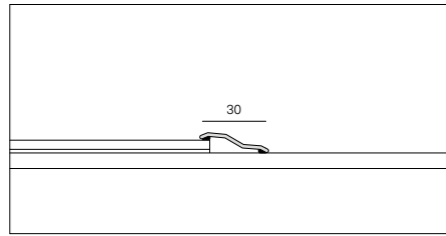
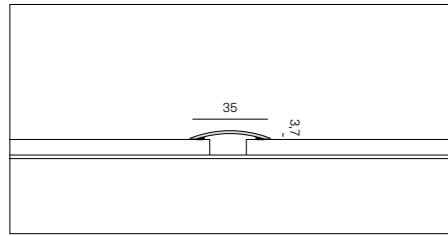

ABACO / RECAP

	DILATAZIONE SINTESY SINTESY EXPANSION	DISLIVELLO SINTESY SINTESY SPLICE PROFILE	KIT DISLIVELLO DA 5 A 7 MM SPLICE KIT 5 TO 7 MM
Collezioni Lines	SPC	-	-
Abbinati Matching	-	Star K Star KR Star KC Star KS Star KD Connex	Star K Star KR Star KC Star KD
Abbinabili Combined	-	-	Star KS
Tinta unita Solid colors	● Argento satinato/ Satin silver	● Argento anodizzato/ Anodized silver	● Argento anodizzato/ Anodized silver
Dimensioni Size	2700x35 mm	2700x29 mm	2700x30 mm

ABACO / RECAP

	KIT TERMINALE DA 5 A 7 MM TERMINAL KIT FROM 5 TO 7 MM	SISTEMA FOLDING PER SPC FOLDING SYSTEM FOR SPC
Collezioni Lines	-	Star KD Star K Star KR Star KS Star KC Star KW
Abbinati Matching	SPC	-
Tinta unita Solid colors	● Argento anodizzato/ Anodized silver	-
Dimensioni Size	2700x25 mm	Dimensione dogia piegata (lunghezza x pedata x alzata) Folded plank size (length x tread x riser) Star KD 914x375x76 mm Star K 1828x140x72 mm Star KR 1500x140x74 mm 1828x150x72 mm Star KC 1500x148x74 mm Star KW Su richiesta/ On demand

Posa Laying

KIT MORSETTI TELESCOPICI TELESCOPIC CLAMP KIT



In fase di partenza il muro non è mai regolare. I morsetti permettono di registrare la distanza tra muro e pavimento in senso longitudinale, accelerando le fasi di posa di un pavimento flottante. Consigliati 2 kit per posatore.

When starting, walls are never perfect. These clamps allow you to register the horizontal distance between the wall and the flooring, for more rapid installation. 2 kits per installer are recommended.

Collezioni
Lines

Pavimenti tecnici/
Technical flooring
Legni/ Wood

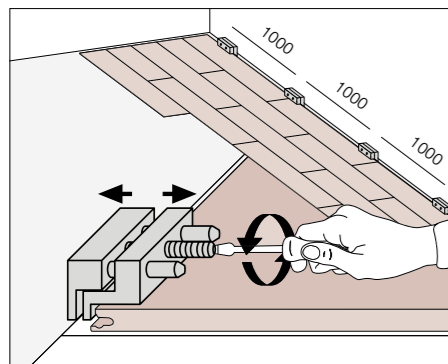

GRIMALDELLO PICKLOCK



È indispensabile per completare l'ultima fila di pavimento, in quanto non c'è spazio per la manovra del martello. Solo per incastri SLS e PLS (no TLS). Consigliati 1 pezzo per posatore.

This tool is required for finishing the last row of the flooring as there is no place enough for using the hammer. We recommend 1 tool per installer.

Collezioni
Lines

Pavimenti tecnici/
Technical flooring
Legni/ Wood

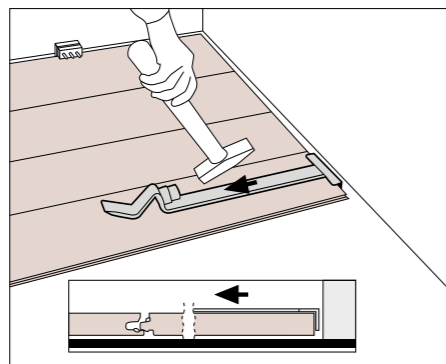

TENSIONATORE CINGHIA BELT TENSIONER



Per pavimenti con incastro a colla. Strumento per compattare le prime tre/ quattro file di doghe, fondamentali per la buona riuscita del lavoro soprattutto con colori chiari su incastri tradizionali a colla. Consigliati 6 pezzi per posatore.

For floorings with glued joints. Used to compact the first three or four rows of planks. Fundamental for good installation, especially for light colours with traditional glued joints. 6 units per installer are recommended.

Collezioni
Lines

Pavimenti tecnici/
Technical flooring
Legni/ Wood

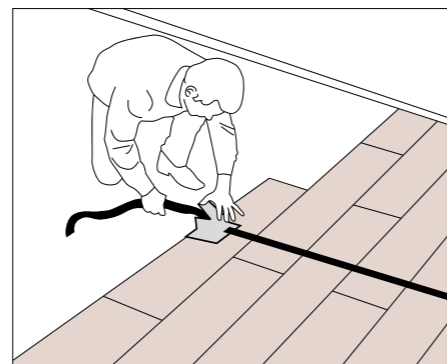

DISTANZIATORE PER PAVIMENTI FLOTTANTI SPACER FOR FLOATING FLOORING



Nei casi in cui si debba fissare al pavimento elementi di arredo o funzionali, consente di evitare il bloccaggio delle dilatazioni del pavimento e conseguenti sollevamenti dello stesso.

If you need to fasten pieces of furniture or functional elements to the flooring, it avoids blocking the flooring expansion and its consequent raising.

Collezioni
Lines

Pavimenti tecnici/
Technical flooring

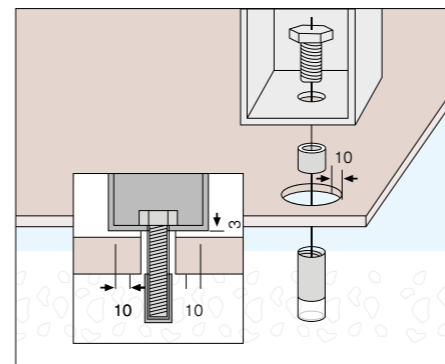

DISTANZIATORE PER PAVIMENTI AV2 AV2 SPACER FOR FLOORING



Distanziatore in plastica per pavimenti flottanti, regolabile 5-20 mm. Plastic spacer for floating floors, adjustable 5-20 mm.

Collezioni
Lines

Pavimenti tecnici/
Technical flooring
Legni/ Wood

BATTITAVOLA PAVIMENTI TECNICI TECHNICAL FLOORING STAVES ALIGNER



Indispensabile per raccordare le doghe. Consigliato 1 pezzo per posatore.

Avvertenza: Usare esclusivamente battitavola originali per evitare di danneggiare l'incastro in modo irreparabile.

Indispensable for aligning the edge of the panels. We recommend 1 tool per installer. Notice: Use only original Staves Aligner to avoid irreparable damages to the joint.

Collezioni
Lines

Pavimenti tecnici/
Technical flooring

ACCESSORI DI MONTAGGIO INSTALLATION ACCESSORIES



Accessori complementari utili per un lavoro preciso e veloce. Accessories complementary for accurate, rapid installation.

Collezioni
Lines

Pavimenti tecnici/
Technical flooring

COLLA NUNIVIL 1008 (D3)
GLUE NUNIVIL 1008 (D3)



Adesivo acetovinilico per pavimenti flottanti con incastro M/F. Consumo medio 35–40 g/m². Consultare la documentazione tecnica sul sito.
Special vinyl adhesive for floating floors with M/F joint. Average consumption 35–40 g/m². Refer to the technical documentation on the website.

Collezioni Lines Pavimenti tecnici/ Technical flooring Legni/ Wood

Confezione 500 gr
Packaging

COLLA ISOCOLL 6307 BEIGE PER BATTISCOPA PVC ESPANSO
GLUE ISOCOLL 6307 BEIGE FOR EXPANDED PVC SKIRTING BOARDS



Colla poliuretanica monocomponente per un ottimo fissaggio del battiscopa in PVC espanso su diverse superfici.
Single component polyurethane adhesive for excellent fastening of expanded PVC skirting board on different surfaces.

Collezioni Lines SPC

Confezione 290 ml
Packaging

COLLA ISOCOLL ECO 6056 BIANCO PER SCALE BATTISCOPA
GLUE ISOCOLL ECO 6056 WHITE FOR STEPS AND SKIRTING BOARDS



Colla monocomponente per il fissaggio del battiscopa e incollaggio gradini.
Single component adhesive for fastening skirting and stair elements.

Collezioni Lines Pavimenti tecnici/ Technical flooring Legni/ Wood

Confezione 290 ml
Packaging

WAX CARE SPRAY



Wax care è una dispersione di cere idrorepellenti per la protezione di pavimenti in legno verniciati o oliati.
Wax care is a dispersion of water-repellent waxes for protection of varnished or oiled wooden floors.

Collezioni Lines Star Wood Star Wood Spina Legni/ Wood

Confezione -
Packaging

PARKETTREINIGER



Detergente per parquet a base di sapone naturale, pH neutro, ideale per la pulizia periodica di pavimenti in legno verniciati o oliati.
Parquet cleaner, natural soap-based, pH-neutral, ideal for regular cleaning of varnished or oiled wooden floors.

Collezioni Lines Lumbertech 270 Oil Palladio Yes

Confezione 1 L
Packaging

DETERGENTE MANUTENTORE CEROSO
WAXY MAINTENANCE CLEANER



Prodotto di manutenzione trasparente a base di cere naturali per il rinnovo ciclico dei pavimenti in legno.
Transparent maintenance product based on natural waxes for the cyclical renewal of wooden floors.

Collezioni Lines Lumbertech 270 Oil Palladio Yes

Confezione 1 L
Packaging

Cura e manutenzione

Care and maintenance

PULISYSTEM



Detergente igienizzante.
Sanitizing detergent.

Collezioni Lines Pavimenti tecnici/ Technical flooring Lumbertech SPC

Confezione 1 L
Packaging

SANITOTAL



Detergente decontaminante.
Attenzione: da utilizzarsi dopo aver lavato le superfici con il prodotto pulisystem.
Decontaminant detergent.
Warning: use only after cleaning surfaces with Pulisystem.

Collezioni Lines Pavimenti tecnici/ Technical flooring Lumbertech SPC

Confezione 1 L
Packaging

MULTILAYER CLEANER



Detergente antistatico sanificante adatto alla pulizia di pavimenti tecnici e vinilici.
Antistatic sanitizing cleaner for technical and vinyl flooring.

Collezioni Lines Pavimenti tecnici/ Technical flooring SPC

Confezione 1 L
Packaging

OLIO PER RITOCO
RETOUCHING OIL



Olio per ritocco e ripristino.
Touch-up and restoration oil.

Collezioni Lines Lumbertech 270 Oil

Confezione 0,125 L
Packaging

CLEANER STAR



Detergente intensivo multiuso per la pulizia di pavimenti in legno verniciati/ olio UV.
Intensive multipurpose cleaner for varnished and UV-oiled wooden floors.

Collezioni Lines Lumbertech 270 Varnish, 205, S700 Palladio

Confezione -
Packaging

OSMO POLYX OIL 3062 MATT



Trattamento speciale di oliatura.
Special oiling treatment.

Collezioni Lines Lumbertech 270 Oil

Confezione -
Packaging

**PACKAGING
E LOGISTICA**
PACKAGING
AND LOGISTICS

Pavimenti in SPC

SPC flooring

Prodotto Product	Rif. formato mm Size mm	Pezzi C fz Pieces Box	m ² C fz m ² Box	Dimensioni scatola mm Box dimensions mm	Kg per scatola Kg per box	C fz pallet Box pallet	m ² pallet m ² pallet	Dimensione pallet (mm) Pallet dimensions (mm)	Kg pallet al m ² Pallet kg per m ²	Peso lordo pallet Pallet Weight
STAR K	1828x218x6	4	1,594	1860x240x30	17,14	68	108,452	1900x980x650	10,75	1181
		6	2,392	1845x230x42	25,10	48	114,819	1870x1000x665	10,75	1260
STAR KR	1500x220x6	6	1,980	1531x242x30	20,96	56	110,880	1570x988x435	10,59	1189
	1828x228x6	4	1,668	1840x240x26	17,38	68	113,415	1865x1010x640	10,42	1205
	1828x218x6	6	1,594	1860x240x30	25,10	48	114,819	1870x1000x665	10,42	1230
STAR KC	1500x228x6	6	2,052	1525x240x40	21,16	52	106,704	1535x975x670	10,31	1145
STAR KS	1498x300x6	6	2,696	1530x322x40	29,12	42	113,249	1570x670x1000	10,8	1225
STAR KD	914x457x6	6	2,506	940x480x40	25,38	40	100,247	970x980x1000	10,12	1030
CONNEX	1500x180x5,5	8	2,16	1515x195x50	19,26	50	108	1540x1000x660	8,92	978
STAR WOOD	1218x165x7	8	1,607	1240x182x60	20,8	72	125,405	1250x1110x910	12,94	1642
	1900x190x7	6	2,166	1928x182x60	20,8	55	119,13	1930x1040x665	12,93	1560
	600x100x7	14	0,84	620x110x100	10,56	144	120,96	1250x930x970	12,57	1540

Skema S.p.A.

Via dell'Artigianato, 8
31047 Ponte di Piave (TV) - Italy

Ph. (+39) 0422 858511
info@skema.eu
www.skema.eu

A.D.

arch. paolo pampanoni

Concept & Graphic

d+a srl

Set design, rendering

virtual design
nudesign srl

Photo

studio antiorario

Printed

grafiche antiga

La riproduzione dei colori è approssimativa.

Skema S.p.A. ha la facoltà esclusiva di modificare e sostituire, anche solo parzialmente, i componenti dei sistemi illustrati in questo folder, senza l'obbligo di darne preavviso.

The reproduction of colors is approximate. Skema S.p.A. has the exclusive right to modify and replace, even only partially, the components of the systems illustrated in this folder, without the obligation to give prior notice.

© Copyright by Skema S.p.A.
All rights reserved

