

# SKEMA

**INDOOR SYNCRO PARQUET**  
PAVIMENTI TECNICI TECHNICAL FLOORING



## SKEMA

Superfici da vivere, dal 1992  
Living surfaces, since 1992

## PAVIMENTI TECNICI TECHNICAL FLOORING

I pavimenti tecnici rappresentano, storicamente, il cuore della proposta di Skema e continuano a essere la scelta migliore in molti contesti per le loro caratteristiche tecniche e il loro realismo.

Ampia la scelta di decori, dall'effetto legno al materico, e di formati, dalla doga al tile.

L'estetica è ricercata grazie al sincroporo, che riproduce fedelmente le venature del legno, e alla superficie opaca e altamente performante.

I pavimenti tecnici sono antistatici e compatibili con il riscaldamento a pavimento.

Technical flooring have historically been the core of Skema's offer and continue to be the best choice in many contexts for their technical characteristics and realistic appearance.

There is a wide choice of patterns, from wood effect to material, and of formats, from planks to tiles.

Aesthetics are sought after thanks to the syncropore technology, which faithfully reproduces the wood grain, and the matte, high-performance surface.

Technical floors are antistatic and compatible with underfloor heating.



**“Una superficie che unisce tecnica ed estetica in un equilibrio naturale. La sintesi perfetta di solidità, durevolezza e forza espressiva.”**

“A surface that blends technology and aesthetics in a natural balance. The perfect synthesis of strength, durability, and expressive character.”

# Syncro Parquet

**La spina in pavimento tecnico,  
dove la tradizione incontra  
l'innovazione.**

The herringbone in technical  
flooring, where tradition meets  
innovation.

**Syncro Parquet reinterpreta l'eleganza intramontabile della posa a spina di pesce, unendo il fascino della tradizione alla praticità delle soluzioni Skema.**

**Disponibile sia nella versione classica sia in quella ungherese con taglio inclinato, permette un'installazione rapida e precisa grazie al sistema d'incastro PLS.**

**I suoi punti di forza sono la protezione dall'acqua garantita dalla tecnologia Hydro Plus, lo spessore ottimizzato di 8 mm, la massima resistenza all'abrasione AC6 e la classe di reazione al fuoco Bfl-s1, che lo rendono adatto anche ad ambienti ad alto traffico come hotel, ristoranti e scuole.**

**Syncro Parquet combina performance tecniche di livello superiore con il pregio estetico della spina di pesce, offrendo un pavimento raffinato e resistente.**

Syncro Parquet reinterprets the timeless elegance of the herringbone pattern, combining the charm of tradition with the practicality of Skema solutions.

Available in both the classic version and the Hungarian cut with angled edges, it allows quick and precise installation thanks to the PLS locking system.

Its strengths include water protection ensured by Hydro Plus technology, an optimized thickness of 8 mm, maximum abrasion resistance AC6, and a Bfl-s1 fire reaction rating, making it suitable even for high-traffic environments such as hotels, restaurants, and schools.

Syncro Parquet combines superior technical performance with the refined aesthetics of herringbone, offering a floor that is both elegant and durable.



## Product

Syncro Parquet - Ungherese 1151, rovere naturale

**CLASSICA/ 1150**  
rovere naturale

1182x293x8 mm

**UNGHERESE/ 1151**  
rovere naturale

1184x293x8 mm

**CHATEAU/ 1164**  
rovere naturale

1183x601x8 mm



## Dati tecnici Technical data

### STRATIGRAFIA/ STRATIGRAPHY

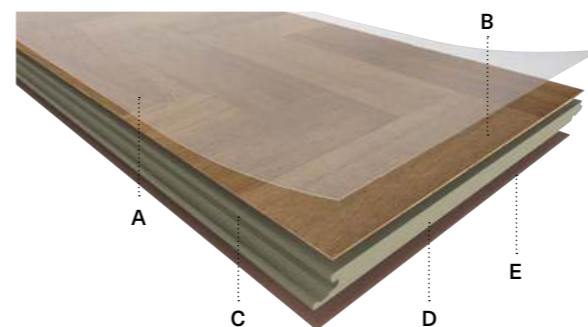

- A. Superficie High Wear**  
High Wear surface
- B. Carta decorativa antistatica**  
Antistatic decorative paper
- C. Strato intermedio HDF trattato**  
Treated HDF intermediate layer
- D. Bordi trattati con Sigil joint**  
Edges treated with Sigil joint
- E. Controbilanciante**  
Balancing layer

### FORMATI/ FORMATS

**Syncro Parquet - Classica**  
1182x293x8 mm

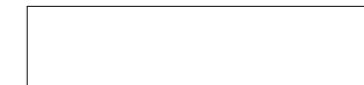

**Syncro Parquet - Ungherese**  
1184x293x8 mm



**Syncro Parquet - Chateau**  
1183x601x8 mm



### CARATTERISTICHE TECNICHE/ TECHNICAL FEATURES

<b>Incastro</b> Joint		<b>PLS</b> (Classica, Ungherese)	<b>Antistatico</b> Antistatic	
		<b>TLS.PF</b> (Chateau)	<b>Umidità/ resistenza all'acqua</b> Moisture/ water resistant	
<b>Bisello</b> Bevel		<b>Sincro bisello</b> stampato sui 4 lati Syncro bevel printed on the 4 sides	<b>Uso domestico</b> Domestic use	 <b>23</b> <b>Alto Traffico</b> High Traffic
<b>Reazione al fuoco*</b> Fire reaction*		<b>Bfl-s1</b>	<b>Uso commerciale</b> Commercial use	 <b>33</b> <b>Alto Traffico</b> High Traffic
<b>Riscaldamento a pavimento</b> Radiant heating		<b>T ≤ 27°C</b>	<b>Classe di abrasione</b> Abrasion class	<b>AC6</b>

\* Classificazione valida con l'utilizzo dei sottopavimenti e/o modalità indicate da Skema S.p.A. (per dettagli vedi scheda tecnica del prodotto e/o istruzioni per l'installazione).  
\* Classification valid with the use of underlayer and/or modality specified by Skema S.p.A. (please see product technical data sheet and/or installation instructions for details).

### ACCESSORI/ ACCESSORIES

<b>Sottopavimenti</b> Underlayer	<b>Superior RBR, DB, ST</b>
<b>Profilo</b> Profile	<b>Kit dislivello, kit dilatazione, kit terminale</b> Splice kit, expansion kit, terminal kit
<b>Battiscopa</b> Skirting board	<b>Star, Time, Look</b>

### SPECIFICHE E CONFORMITÀ/ SPECIFICATIONS AND COMPLIANCE



### CONFEZIONAMENTO/ PACKAGING

Rif. formato/ Size	Pezzi C fz/ Pieces Box	m <sup>2</sup> C fz/ Box	C fz Pallet/ Box Pallet	m <sup>2</sup> Pallet
1184x293 mm	6	2,081	51	106,30
1182x293 mm	6	2,078	51	106,02
1183x601 mm	3	2,133	68	145,40

**ACCESSORI**  
ACCESSORIES

# Sottopavimenti Underlayers

## SUPERIOR RBR



Alte performance; densità media 800 kg/m<sup>3</sup>; soddisfa lo standard EPLF; ottima resistenza meccanica CS a protezione dell'incastro; alta performance acustica IS per riduzione riverbero in stanza RWS; bassa resistenza termica TR, consigliato per posa su massetti radianti; barriera vapore integrata (PET/Alu); bassissima emissione VOC; posa lato PET/Alluminio verso l'alto.  
High performance; average density 800 kg/m<sup>3</sup>; fulfils EPLF standards; excellent mechanical resistance CS to protect the joint; high acoustic performance IS for room reverberation reduction RWS; low thermal resistance TR, recommended for laying on radiant screeds; integrated vapour barrier (PET/Alu); very low VOC emission; PET/Alu side up laying.

**Dimensioni**  
Size

**Rotolo/ Roll 8x1 m**  
Sp. 2 mm | D 800 kg/mc

## DB



Costituito da schiuma poliolefinica a celle chiuse estrusa in modalità controllata; densità media 80kg/m<sup>3</sup>; soddisfa standard EPLF; resistenza meccanica CS; isolamento al rumore da calpestio IS; barriera vapore SD (PET) che evita diffusione di umidità di risalita, integrata con cimosa laterale dotata di nastro adesivo applicato per congiunzione materassini; senza CFC e HCFC, plastificanti e metalli pesanti; posa con lato nero con barriera vapore verso l'alto.  
Consisting of closed-cell polyolefin foam extruded in a controlled mode; average density 80 kg/m<sup>3</sup>; fulfils EPLF standard; mechanical resistance CS; impact sound insulation IS; vapour barrier SD (PET) preventing diffusion of moisture, integrated with side selvedge with adhesive tape applied for mattress connection; free of CFCs and HCFCs, plasticisers and heavy metals; laid with black side with vapour barrier facing upwards.

**Dimensioni**  
Size

**Rotolo/ Roll 25x1 m**  
Sp. 2 mm | D 80 kg/mc

## ST



Costituito da schiuma poliolefinica a celle chiuse estrusa in modalità controllata; densità media 20kg/m<sup>3</sup>; soddisfa standard EPLF; resistenza meccanica CS; isolamento al rumore da calpestio IS; barriera vapore SD (PET/Alluminio) integrata che evita diffusione di umidità di risalita; senza CFC e HCFC, plastificanti e metalli pesanti; posare con lato metallizzato verso l'alto.  
Consisting of closed-cell polyolefin foam extruded in a controlled manner; average density 20 kg/m<sup>3</sup>; meets EPLF standard; mechanical resistance CS; impact sound insulation IS; integrated SD vapour barrier (PET/Aluminium) that prevents the diffusion of rising damp; free of CFCs and HCFCs, plasticisers and heavy metals; lay with metallised side up.

**Dimensioni**  
Size

**Rotolo/ Roll 25x1 m**  
Sp. 2 mm | D 20 kg/mc

**Rotolo/ Roll 150x1 m**  
Sp. 2 mm | D 20 kg/mc

# Battiscopa Skirting boards

## STAR

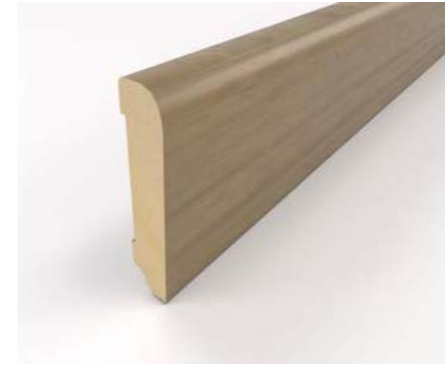

Battiscopa in HDF con proporzioni standard.  
HDF skirting board with standard proportions.

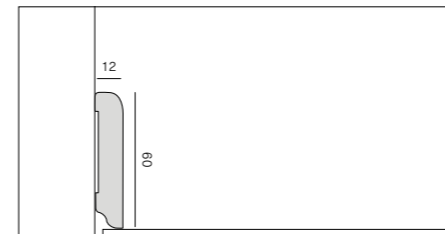

## TIME



Battiscopa in HDF.  
Skirting board made of HDF.

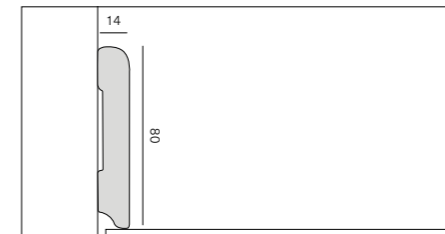

## LOOK



Battiscopa in HDF con finitura poro.  
Skirting board made of HDF with a pore finish.

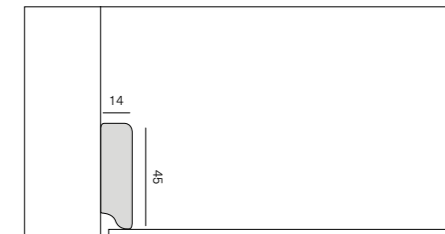

## ABACO / RECAP

	STAR	TIME	LOOK
<b>Abbinati</b> Matching	Facile+	Prestige L Prestige Gold	Prestige L Prestige Gold Vision Technic
<b>Abbinabili</b> Combined	Syncro Parquet	Lumbertech	-
<b>Tinta unita</b> Solid colors	○ Bianco opaco/ Matt white	○ Bianco lucido/ Glossy white ○ Bianco opaco/ Matt white ○ Grigio chiaro/ Light grey ● Grigio medio/ Medium grey ● Grigio scuro/ Dark grey ● Nero opaco/ Matt black ● Carbonio/ Carbon ○ Beige ○ Avorio/ Ivory ● Metallo bronzo/ Bronze metal	● Alluminio/ Aluminum ○ Bianco lucido/ Glossy white ○ Bianco opaco/ Matt white ○ Grigio chiaro/ Light grey ● Grigio medio/ Medium grey ● Grigio scuro/ Dark grey ● Nero opaco/ Matt black ● Carbonio/ Carbon ○ Beige ○ Avorio/ Ivory ● Metallo bronzo/ Bronze metal
<b>Dimensioni</b> Size	h 60-2400x12 mm	h 80-2400x14 mm	h 45-2400x14 mm h 45-2200x14 mm

**DROP**

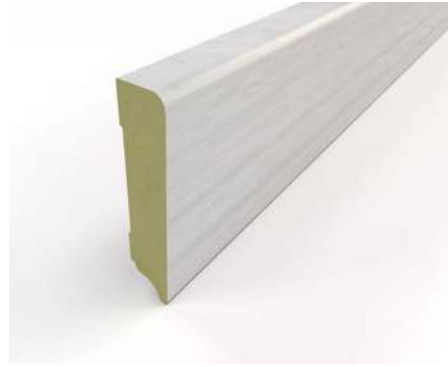

**Battiscopa in HDF a bassa assorbenza con finiture poro. Con densità di 700 kg/m³ offre alta resistenza all'umidità.**  
HDF skirting board with low absorbency and a sealed finish. Its 700 kg/m³ density ensures high moisture resistance.

**PVC ESPANSO**

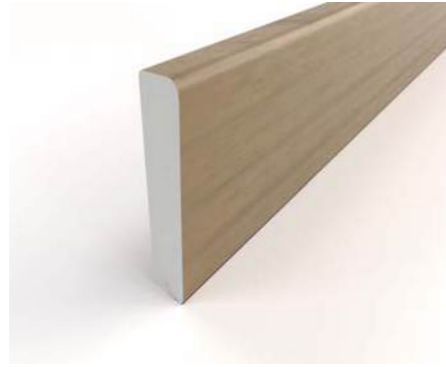

**Battiscopa in PVC espanso resistente all'umidità.**  
Moisture-resistant expanded PVC skirting board.

**F**



**Battiscopa realizzato con sistema folding utilizzando le relative doghe del pavimento.**  
Skirting board made with a folding system using the matching floor planks.

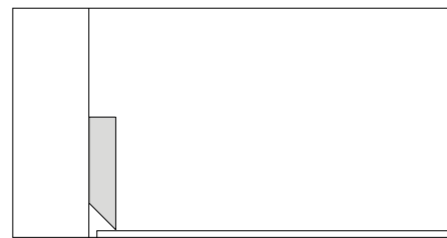
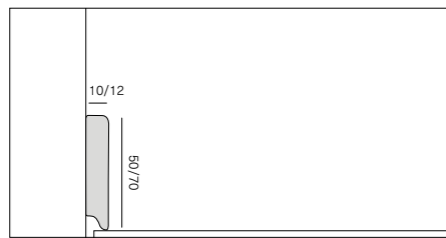
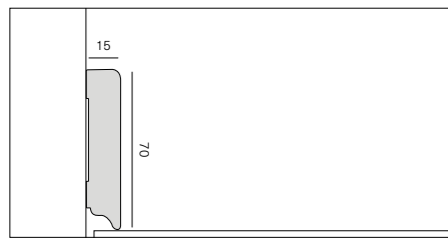

**ABACO / RECAP**

	DROP	PVC ESPANSO	F
<b>Abbinati</b> Matching	K-Uno	Star K Star KR Star KC Star KD Connex	Yes
<b>Abbinabili</b> Combined	-	Star KS Star Wood Star Wood Spina	-
<b>Tinta unita</b> Solid colors	○ Bianco/ White - RAL 9003, 9010	○ Bianco/ White - RAL 9003, 9010 ● Nero/ Black ● Alluminio/ Aluminum - RAL 9006	-
<b>Dimensioni</b> Size	h 70-2400x15 mm	h 50-2400x12 mm h 70-2400x12 mm	Variabile/ Variable

**W45**



**Profilo per battiscopa realizzato in MDF rivestito di tranciato di vero legno con finiture verniciate a poro aperto (gruppo 1) e, per i colorati, con stampa digitale successivamente verniciato (gruppo 2).**  
Skirting board profile made of MDF and covered with real wood veneer. Two types of finishings available: open pore varnished finishing (group 1) and a coloured finishing made by digital printing process and then varnished (group 2).

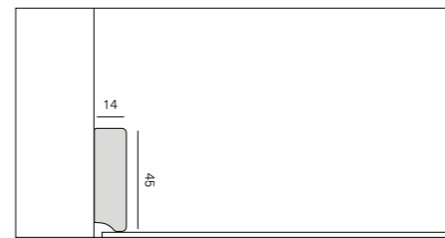

**W75**



**Profilo per battiscopa realizzato in MDF rivestito di tranciato di vero legno con finiture verniciate a poro aperto (gruppo 1) e, per i colorati, con stampa digitale successivamente verniciato (gruppo 2).**  
Skirting board profile made of MDF and covered with real wood veneer. Two types of finishings available: open pore varnished finishing (group 1) and a coloured finishing made by digital printing process and then varnished (group 2).

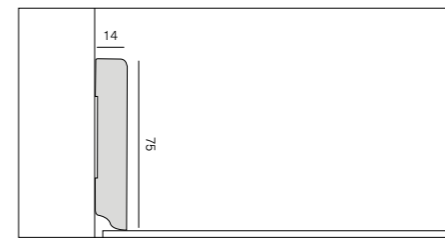

**ABACO / RECAP**

	W45	W75
<b>Abbinabili</b> Combined	Palladio Yes	Palladio Yes
<b>Dimensioni</b> Size	h 45-2400x14 mm	h 75-2400x14 mm

# Profili

## Profiles

**PARAGRADINO ANTISDRUCCIOLO**  
NO-SLIP STAIR PROTECTOR



Paragradino antisdrucciolo in alluminio, che consente di rivestire il raccordo tra alzata e pedata di una scala.

**Acquistare sempre con antiscivolo autoadesivo.**  
Non-slip aluminum stair nosing, used to cover the transition between the riser and tread of a staircase. Always purchase with self-adhesive non-slip tape.

**ANGOLARE AD L**  
L-SHAPED CORNER PROFILE

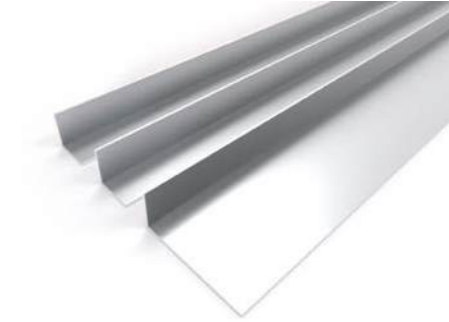

Profilo in alluminio per finiture di raccordi a muro.

Aluminium profile for finishing wall connections.

**PROFILO DI BORDO**  
BORDER PROFILE

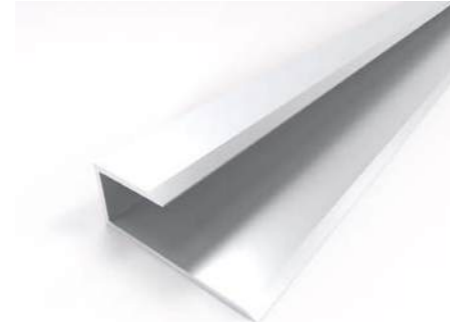

Profilo in alluminio estruso per bordature perimetrali per pavimenti.

Extruded aluminium profile for perimeter edging of floors.

**PROFILO DI BORDO CURVABILE**  
CURVABLE BORDER PROFILE



Profilo in alluminio estruso curvabile per bordature perimetrali.

Extruded curvable aluminium profile for perimeter edging.

**PROFILO SCALA 45°**  
45° STAIR PROFILE



Profilo paragradino in alluminio anodizzato argento per protezione e finitura arrotondata degli angoli esterni.

Silver anodized aluminum step nosing profile for protection and rounded finishing of external corners.

**TORO SCALA ELITE**  
ELITE STAIR NOSE



Toro scala in HDF, da abbinare esclusivamente alla maschiatura sul lato lungo dei pavimenti. Fissaggio con collante specifico.

HDF stair bullnose, to be combined exclusively with the tongue on the long side of the flooring. Fix with specific adhesive.

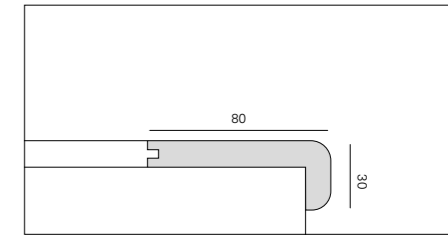
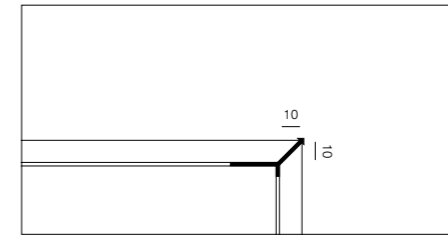
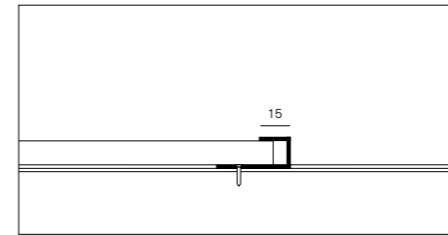
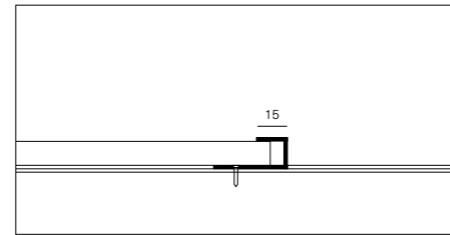
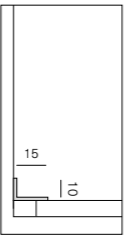
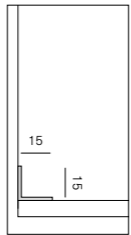
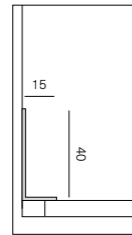
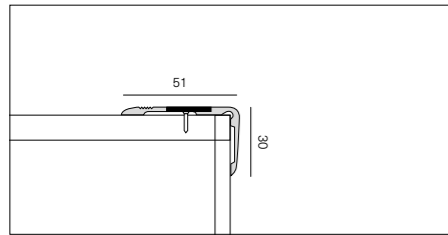

### ABACO / RECAP

	PARAGRADINO ANTISDRUCCIOLO NO-SLIP STAIR PROTECTOR	ANGOLARE AD L L-SHAPED CORNER PROFILE	PROFILO DI BORDO BORDER PROFILE
<b>Collezioni</b> Lines	Pavimenti tecnici/ Technical flooring SPC Legni/ Wood	Pavimenti tecnici/ Technical flooring SPC Legni/ Wood	Pavimenti tecnici/ Technical flooring SPC Legni/ Wood
<b>Tinta unita</b> Solid colors	● Argento anodizzato/ Anodized silver ● Oro anodizzato/ Anodized gold ● Bronzo anodizzato/ Anodized bronze	● Argento/ Silver ● Bronzo/ Bronze	● Argento/ Silver ● Oro/ Gold
<b>Dimensioni</b> Size	3400x52x30 mm  18 m rotolo striscia antiscivolo autoadesiva/ 18 m roll self-adhesive non-slip strip	● 2000/3000x15x10 mm spessore 1,0 mm/ 1.0 mm thick  ● 2000x15x15 mm spessore 1,5 mm/ 1.5 mm thick  ● 2000x45x40 mm spessore 2,0 mm/ 2.0 mm thick	2700x15x6 mm 2700x15x7 mm 2700x15x9 mm 2700x15x11 mm 2700x15x15 mm

### ABACO / RECAP

	PROFILO DI BORDO CURVABILE CURVABLE BORDER PROFILE	PROFILO SCALA 45° 45° STAIR PROFILE	TORO SCALA ELITE ELITE STAIR NOSE
<b>Collezioni</b> Lines	Pavimenti tecnici/ Technical flooring SPC Legni/ Wood	-	-
<b>Collezioni abbinate</b> Matching lines	-	K-Uno	K-Uno Prestige L Prestige Gold
<b>Tinta unita</b> Solid colors	● Argento/ Silver ● Oro/ Gold ● Bronzo/ Bronze	● Argento/ Silver	-
<b>Dimensioni</b> Size	Pavimenti tecnici/ Technical flooring ● 2700x15x9 mm - 2700x15x11 mm  SPC ● 2700x15x7 mm  Legni/ Wood ● 2700x15x11 mm ● 2700x15x13 mm - 2700x15x15 mm	3000x10 mm spessore 10 mm/ 10 mm thick	2430x80x30 mm  K-Uno spessore 10 mm/ 10 mm thick  Prestige L - Prestige Gold spessore 8 mm/ 8 mm thick

**KIT DILATAZIONE**  
EXPANSION KIT



Kit dilatazione abbinabile e in alluminio con Pin Unico per pavimenti con spessore da 6 a 12,5 mm, con base femmina in alluminio.  
Aluminum expansion kit with Single Pin for floorings with thickness from 6 to 12,5 mm and aluminum female base.

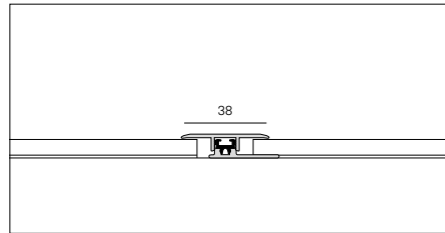

**KIT DISLIVELLO DA 6 A 12,5 MM**  
SPLICE KIT 6 TO 12,5 MM



Kit dislivello in alluminio con Pin Unico per pavimenti con spessore da 6 a 12,5 mm con base femmina in alluminio.  
Aluminium transition kit with Single Pin for floors with thickness from 6 to 12.5 mm, with aluminium female base.

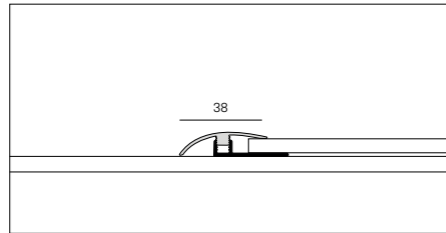

**KIT TERMINALE**  
TERMINAL KIT



Kit terminale in alluminio con Pin Unico per pavimenti con spessore da 9 a 12,5 mm con base femmina in alluminio.  
Aluminium end kit with Single Pin for floors with thickness from 9 to 12.5 mm, with aluminium female base.

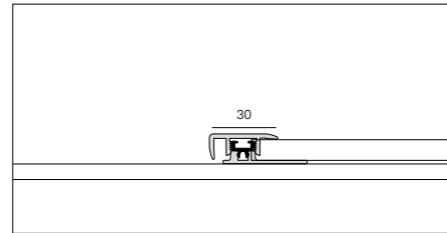

**CLIP DI AGGANCIO**  
RETAINING CLIP



Clip di aggancio in metallo zincato nero che, con rotazione sull'omega, fissa pannelli e doghe alla struttura.  
Black galvanized metal clip that, by rotating onto the omega, secures panels and slats to the structure.

Collezioni Lines	K-Uno Prestige L Lumbertech
Dimensioni Size	44x41 mm
Confezione Packaging	200 pz/ pcs

**ABACO / RECAP**

	KIT DILATAZIONE EXPANSION KIT	KIT DISLIVELLO DA 6 A 12,5 MM SPLICE KIT 6 TO 12,5 MM	KIT TERMINALE TERMINAL KIT
Collezioni Lines	Pavimenti tecnici/ Technical flooring Legni/ Wood	-	Pavimenti tecnici/ Technical flooring Legni/ Wood
Abbinati Matching	K-Uno Prestige L Prestige Gold Facile+ Vision Oxid Vision Technic Lumbertech	Pavimenti tecnici/ Technical flooring	-
Abbinabili Combined	Syncro Parquet	-	-
Tinta unita Solid colors	● Argento anodizzato/ Anodized silver	● Argento anodizzato/ Anodized silver	● Argento/ Silver
Dimensioni Size	2700x38 mm	2700x38 mm 2700x45 mm	2700x30 mm

## Accessori per pavimenti sopraelevati

### Accessories for raised floors

**COLONNA BASE FILETTATA**  
COLUMN WITH THREADED BASE



Altezza Min Max  
Min-Max Height

40-60 mm
50-80 mm
60-100 mm
100-150 mm

**COLONNA BASE INNESTATA**  
COLUMN WITH EMBEDDED BASE



Altezza Min Max  
Min-Max Height

120-180 mm
140-190 mm
160-230 mm
190-260 mm
220-290 mm
260-330 mm
300-370 mm
340-410 mm
380-450 mm
420-490 mm
460-530 mm

**TRAVERSO CON GUARNIZIONE BASIC**  
CROSS-PIECE WITH SEAL BASIC



Dimensioni  
Size

35 mm
spessore 0,9 mm/ 0,9 mm thick

## Accessori per rivestimenti a parete e soffitto

### Accessories for wall and ceiling coverings

**PROFILO OMEGA**  
OMEGA PROFILE



Il profilo ad omega costituisce l'elemento per il fissaggio a parete tramite viti o tasselli e deve essere montato ad una struttura portante tipo cartongesso o al muro da rivestire.

Omega cross-section profile is the element that fastens the boards to the wall. It must be installed using screws or wall plugs to a load bearing structure, such as drywall or the wall to be covered.

Dimensioni  
Size

3000x25x26 mm
3000x13x26 mm

## Posa

### Laying

**KIT MORSETTI TELESCOPICI**  
TELESCOPIC CLAMP KIT



In fase di partenza il muro non è mai regolare. I morsetti permettono di registrare la distanza tra muro e pavimento in senso longitudinale, accelerando le fasi di posa di un pavimento flottante. Consigliati 2 kit per posatore.

When starting, walls are never perfect. These clamps allow you to register the horizontal distance between the wall and the flooring, for more rapid installation.

2 kits per installer are recommended.

Collezioni  
Lines

Pavimenti tecnici/ Technical flooring
Legni/ Wood

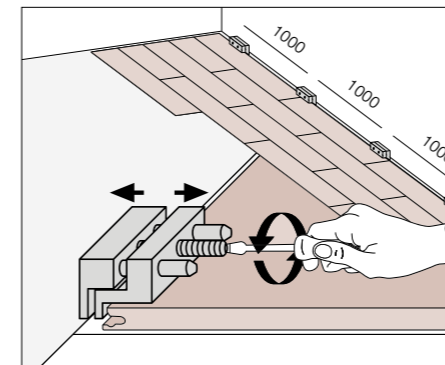

**GRIMALDELLO**  
PICKLOCK



È indispensabile per completare l'ultima fila di pavimento, in quanto non c'è spazio per la manovra del martello. Solo per incastri SLS e PLS (no TLS). Consigliati 1 pezzo per posatore.

This tool is required for finishing the last row of the flooring as there is no place enough for using the hammer.

We recommend 1 tool per installer.

Collezioni  
Lines

Pavimenti tecnici/ Technical flooring
Legni/ Wood

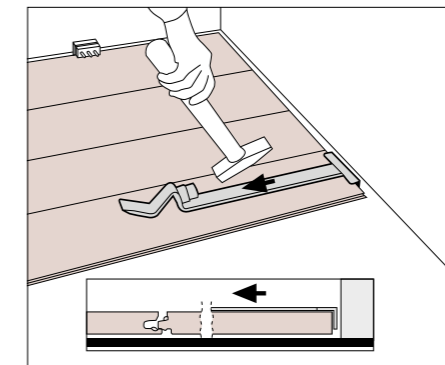

**TENSIONATORE CINGHIA**  
BELT TENSIONER



Per pavimenti con incastro a colla. Strumento per compattare le prime tre/ quattro file di doghe, fondamentali per la buona riuscita del lavoro soprattutto con colori chiari su incastri tradizionali a colla. Consigliati 6 pezzi per posatore.

For floorings with glued joints. Fundamental for good installation, especially for light colours with traditional glued joints.

6 units per installer are recommended.

Collezioni  
Lines

Pavimenti tecnici/ Technical flooring
Legni/ Wood

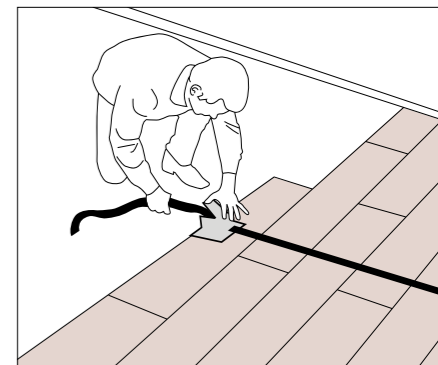

**DISTANZIATORE PER PAVIMENTI FLOTTANTI**  
SPACER FOR FLOATING FLOORING



Nei casi in cui si debba fissare al pavimento elementi di arredo o funzionali, consente di evitare il bloccaggio delle dilatazioni del pavimento e conseguenti sollevamenti dello stesso.  
If you need to fasten pieces of furniture or functional elements to the flooring, it avoids blocking the flooring expansion and its consequent raising.

**DISTANZIATORE PER PAVIMENTI AV2**  
AV2 SPACER FOR FLOORING



Distanziatore in plastica per pavimenti flottanti, regolabile 5-20 mm.  
Plastic spacer for floating floors, adjustable 5-20 mm.

**BATTITAVOLA PAVIMENTI TECNICI**  
TECHNICAL FLOORING STAVES ALIGNER



Indispensabile per raccordare le doghe. Consigliato 1 pezzo per posatore.  
**Avvertenza: Usare esclusivamente battitavola originali per evitare di danneggiare l'incastro in modo irreparabile.**  
Indispensable for aligning the edge of the panels. We recommend 1 tool per installer.  
Notice: Use only original Staves Aligner to avoid irreparable damages to the joint.

**COLLA NUNIVIL 1008 (D3)**  
GLUE NUNIVIL 1008 (D3)



Adesivo acetovinilico per pavimenti flottanti con incastro M/F. Consumo medio 35-40 g/m<sup>2</sup>.  
**Consultare la documentazione tecnica sul sito.**  
Special vinyl adhesive for floating floors with M/F joint. Average consumption 35-40 g/m<sup>2</sup>.  
Refer to the technical documentation on the website.

**COLLA ISOCOLL 6307 BEIGE PER BATTISCOPA PVC ESPANSO**  
GLUE ISOCOLL 6307 BEIGE FOR EXPANDED PVC SKIRTING BOARDS



Colla poliuretanica monocomponente per un ottimo fissaggio del battiscopa in PVC espanso su diverse superfici.  
Single component polyurethane adhesive for excellent fastening of expanded PVC skirting board on different surfaces.

**COLLA ISOCOLL ECO 6056 BIANCO PER SCALE BATTISCOPA**  
GLUE ISOCOLL ECO 6056 WHITE FOR STEPS AND SKIRTING BOARDS



Colla monocomponente per il fissaggio del battiscopa e incollaggio gradini.  
Single component adhesive for fastening skirting and stair elements.

Collezioni Lines Pavimenti tecnici/ Technical flooring

Collezioni Lines Pavimenti tecnici/ Technical flooring Legni/ Wood

Collezioni Lines Pavimenti tecnici/ Technical flooring

Collezioni Lines Pavimenti tecnici/ Technical flooring Legni/ Wood

Collezioni Lines SPC

Collezioni Lines Pavimenti tecnici/ Technical flooring Legni/ Wood

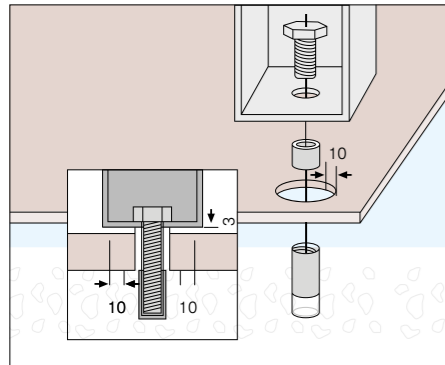

**ACCESSORI DI MONTAGGIO**  
INSTALLATION ACCESSORIES



Accessori complementari utili per un lavoro preciso e veloce.  
Accessories complementary for accurate, rapid installation.

Collezioni Lines Pavimenti tecnici/ Technical flooring

Confezione Packaging 500 gr

Confezione Packaging 290 ml

Confezione Packaging 290 ml

# Cura e manutenzione

## Care and maintenance

### PULISYSTEM



**Detergente igienizzante.**  
Sanitizing detergent.

Collezioni Lines Pavimenti tecnici/ Technical flooring Lumbertech SPC

Confezione Packaging 1 L

### SANITOTAL



**Detergente decontaminante.**  
**Attenzione: da utilizzarsi dopo aver lavato le superfici con il prodotto pulisystem.**  
Decontaminant detergent.  
Warning: use only after cleaning surfaces with Pulisystem.

Collezioni Lines Pavimenti tecnici/ Technical flooring Lumbertech SPC

Confezione Packaging 1 L

### MULTILAYER CLEANER



**Detergente antistatico sanificante adatto alla pulizia di pavimenti tecnici e vinilici.**  
Antistatic sanitizing cleaner for technical and vinyl flooring.

Collezioni Lines Pavimenti tecnici/ Technical flooring Lumbertech SPC

Confezione Packaging 1 L

### OLIO PER RITOCOCCO RETOUCHING OIL



**Olio per ritocco e ripristino.**  
Touch-up and restoration oil.

Collezioni Lines Lumbertech 270 Oil

Confezione Packaging 0,125 L

### CLEANER STAR



**Detergente intensivo multiuso per la pulizia di pavimenti in legno verniciati/ olio UV.**  
Intensive multipurpose cleaner for varnished and UV-oiled wooden floors.

Collezioni Lines Lumbertech 270 Varnish, 205, S700 Palladio

Confezione Packaging -

### OSMO POLYX OIL 3062 MATT



**Trattamento speciale di oliatura.**  
Special oiling treatment.

Collezioni Lines Lumbertech 270 Oil

Confezione Packaging -

### WAX CARE SPRAY



**Waxe care è una dispersione di cere idrorepellenti per la protezione di pavimenti in legno verniciati o oliati.**  
Waxe care is a dispersion of water-repellent waxes for protection of varnished or oiled wooden floors.

Collezioni Lines Star Wood Star Wood Spina Legni/ Wood

Confezione Packaging -

### PARKETTREINIGER



**Detergente per parquet a base di sapone naturale, pH neutro, ideale per la pulizia periodica di pavimenti in legno verniciati o oliati.**  
Parquet cleaner, natural soap-based, pH-neutral, ideal for regular cleaning of varnished or oiled wooden floors.

Collezioni Lines Lumbertech 270 Oil Palladio Yes

Confezione Packaging 1 L

### DETERGENTE MANUTENTORE CEROSO WAXY MAINTENANCE CLEANER



**Prodotto di manutenzione trasparente a base di cere naturali per il rinnovo ciclico dei pavimenti in legno.**  
Transparent maintenance product based on natural waxes for the cyclical renewal of wooden floors.

Collezioni Lines Lumbertech 270 Oil Palladio Yes

Confezione Packaging 1 L

**PACKAGING  
E LOGISTICA**  
PACKAGING  
AND LOGISTICS

# Pavimenti tecnici

## Technical flooring

Prodotto Product	Rif. formato mm Size mm	Pezzi C fz Pieces Box	m <sup>2</sup> C fz m <sup>2</sup> Box	Dimensioni scatola mm Box dimensions mm	Kg per scatola Kg per box	C fz pallet Box pallet	m <sup>2</sup> pallet m <sup>2</sup> pallet	Dimensione pallet (mm) Pallet dimensions (mm)	Kg pallet al m <sup>2</sup> Pallet kg per m <sup>2</sup>	Peso lordo pallet Pallet Weight
K-UNO	2052x248x10	4	2,035	2070x260x40	18,38	42	85,494	2110x830x750	9,03	787
SYNCRO PARQUET	1184x293x8	6	2,081	1210x305x50	16,14	51	106,3	1220x930x1000	7,75	839
	1182x293x8	6	2,078	1210x305x50	17,08	51	106,02	1220x930x1000	8,22	886
	1183x601x8	3	2,132	1210x610x25	18,32	68	145.40.00	1220x1230x1030	8,59	1261
PRESTIGE GOLD	1288x198x8	10	2,55	1302x210x80	18,9	40	102,01	1305x850x960	7,4	770
PRESTIGE L	2052x220x8	6	2,708	2069x236x48	20,12	36	97,511	2120x930x585	7,43	740
FACILE+	1288x198x8	10	2,55	1302x210x80	18,44	40	102,01	1305x850x960	7,23	753
VISION OXID	1183x396x8	5	2,34	1210x405x45	19,82	42	98,295	1220x830x1020	8,46	848
	1184x601x8	3	2,135	1210x610x25	17,02	68	145,163	1220x1230x1030	7,98	1172
VISION TECHNIC	857x398x8	7	2,387	870x410x55	17,65	30	71,61	1240x880x700	7,4	546

**Skema S.p.A.**

Via dell'Artigianato, 8  
31047 Ponte di Piave (TV) - Italy

Ph. (+39) 0422 858511  
info@skema.eu  
www.skema.eu

**A.D.**

arch. paolo pampanoni

**Concept & Graphic**

d+a srl

**Set design, rendering**

virtual design  
nudesign srl

**Photo**

studio antiorario

**Printed**

grafiche antiga

La riproduzione dei colori è approssimativa.

Skema S.p.A. ha la facoltà esclusiva di modificare e sostituire, anche solo parzialmente, i componenti dei sistemi illustrati in questo folder, senza l'obbligo di darne preavviso.

The reproduction of colors is approximate. Skema S.p.A. has the exclusive right to modify and replace, even only partially, the components of the systems illustrated in this folder, without the obligation to give prior notice.

© Copyright by Skema S.p.A.  
All rights reserved

